



目录	页面	Contents	Page
R系列圆柱斜齿轮减速机		R Series Helical Gear Motor	
产品外形	2-2	Products Figure	2-2
型号标记	3-3	Designation	3-3
电机配置说明	3-4	Configuration of Electric Motor	3-4
安装位置	5-8	Mounting Position	5-8
技术参数	9-95	Technical Data	9-95
安装尺寸	96-137	Mounting Dimensions	96-137
RM型减速机	138-142	RM Gear Unit	138-142



产品外形

Products Figure

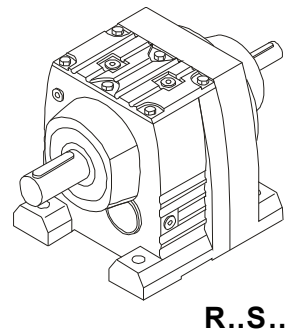
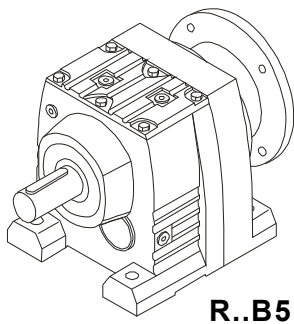
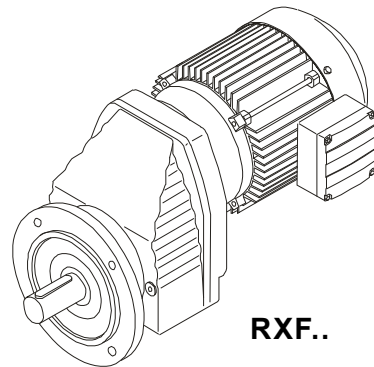
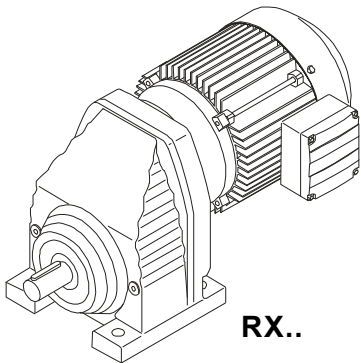
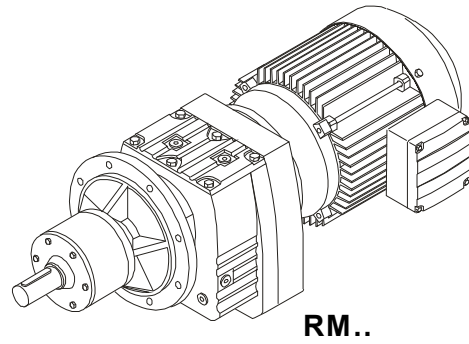
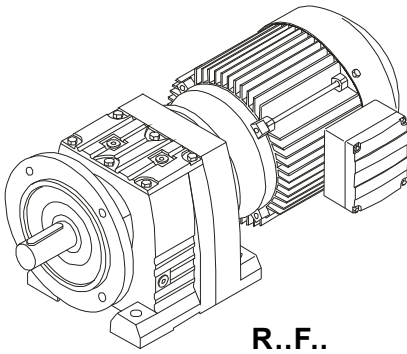
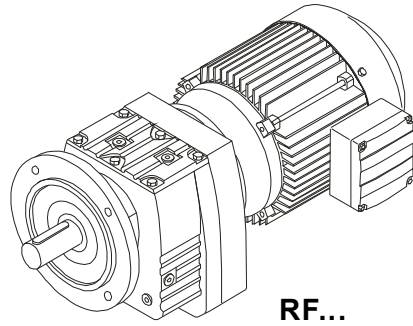
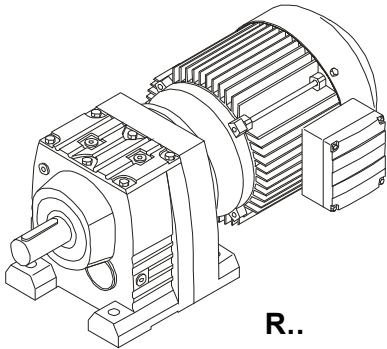



型号标记

Designation

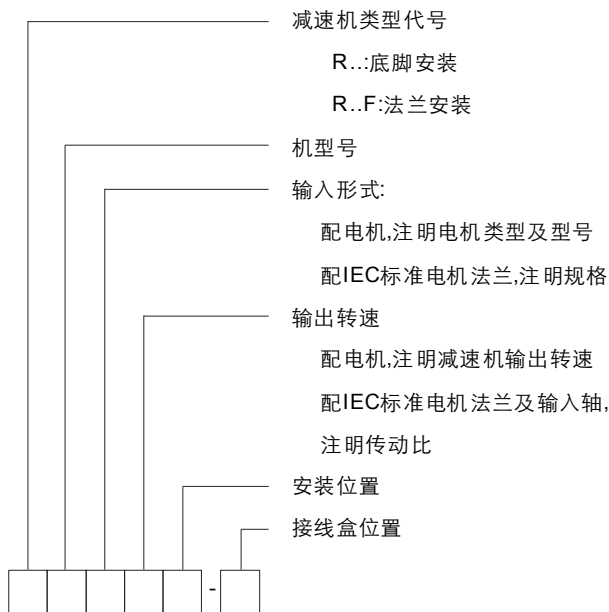

gear unit type
R...:foot-mounted
R..F:flange-mounted

gear unit size

input structure:
connect with motor, indicate motor model
connect with IEC flange, indicate frame

output speed
connect with motor, indicate output speed
connect with IEC flange or input shaft, indicate ratio

mounting position

terminal box position

标记示例

- A R47Y71M2-4NA12M1-0
底脚安装,机型号47,电机规格71M2-4,输出转速12rpm,安装位置M1,电机接线盒位置0°
- B R67YB100L1-4NA38M2-180 (dII BT4 IP54/F)
底脚安装,机型号67,防爆电机YB100L1-4,防爆等级dII BT4,防护等级IP54,绝缘等级F,输出转速38rpm,安装位置M2,电机接线盒位置180°
- C RF167-160B5-159-M2 (? 50)
法兰安装,机型号167,电机法兰160B5,减速比159,安装位置M2,法兰外径Ø550.

Sign Example

- A R47Y71M2-4NA12M1-0
foot-mounted, gear unit size 47, motor size 71M2-4, output speed 12rpm, mounting position M1, terminal box 0
- B R67YB100L1-4NA38M2-180 (dII BT4 IP54/F)
foot-mounted, gear unit size 67, motor size YB100L1-4, output speed 38rpm, mounting position M2, terminal box 180
- C RF167-160B5-159-M2 (? 50)
flange-mounted, gear unit size 167, motor flange 160B5, transmission ratio 159, mounting position M2, output flange diameter Ø550.

电机配置说明

Configuration of Electric Motor

Y系列普通三相异步电机

Y series Three-phase Asynchronous Electric Motor

- 1 本系列减速机标准配置Y系列普通三相异步感应电机;
- 2 电机电压: 380V/50Hz;
- 3 电机防护等级IP54, 绝缘等级F, B级温升;
- 4 环境温度不超过40°C,不低于-15°C;
- 5 连续工作制S1;
- 6 海拔高度不超过1000m;
- 7 冷却方式为C0141(风扇自冷);
- 8 100及以下规格为"Y"接法, 112M及以上规格为"Δ"接法;
- 9 优先选用4, 6, 8极电机, 2极电机不推荐使用;
- 10 电机技术参数见第433-438页

- 1 this series gear unit configure three-phase asynchronous electric motor;
- 2 voltage:380V/50Hz;
- 3 protection class:IP54,insulation class: F; temperature rising class: B;
- 4 ambient temperature:-15~40C ;
- 5 continue working duty:S1;
- 6 altitude less than 1000m;
- 7 self-cooling with fan:C0141;
- 8 within frame 100, follow connection Y, from frame 112, follow connection Δ ;
- 9 first select 4,6,8 poles motor;
- 10 technical data on page 433-438.



电机配置说明

Configuration of Electric Motor

YEJ系列三相异步制动电机

- 1 三相异步制动电机为普通电机的基础上附加制动器;
- 2 电机电压: 380V/50Hz;
- 3 制动器电压: 规格71~100: DC99V
规格112~200: DC170V
- 4 配置单相AC220/50Hz整流器;
- 5 电机防护等级IP44, 绝缘等级F, B级温升;
- 6 环境温度不超过40℃, 不低于-15℃;
- 7 连续工作制S1;
- 8 海拔高度不超过1000m;
- 9 冷却方式为C0141 (风扇自冷);
- 10 100及以下规格为"Y"接法, 112M及以上规格为"Δ"接法;
- 11 优先选用4, 6, 8极电机, 2极电机不推荐使用。
- 12 电机技术参数见第433-438页

YEJ series Three-phase Asynchronous Brake Motor

- 1 base on Y series motor, add a brake.
- 2 voltage:380V/50Hz;
- 3 brake voltage: frame:71~100 DC99V
frame:112~200 DC170V;
- 4 with single phase AC220V/50Hz rectifier;
- 5 protection class:IP54,insulation class: F, temperature rising class: B;
- 6 ambient temperature:-15~40C ;
- 7 continue working duty:S1;
- 8 altitude less than 1000m;
- 9 self-cooling with fan:C0141;
- 10 upon to frame 100, follow connection Y, from frame 112, follow connection Δ ;
- 11 first select 4,6,8 poles motor;
- 12 technical data on page 433-438.

YVF系列三相异步变频电机

- 1 电机电压: 380V;
- 2 基准频率: 50Hz;
- 3 允许调频5~50Hz, 恒转矩调速;
- 4 电机防护等级IP54, 绝缘等级F, B级温升;
- 5 环境温度不超过40℃, 不低于-15℃;
- 6 连续工作制S1;
- 7 海拔高度不超过1000m;
- 8 冷却方式为C416 (独立风扇);
- 9 接线方式按适配变频器要求;
- 10 优先选用4极电机。

YVF series Three-phase Variable-frequency Motor

- 1 voltage:380V;
- 2 rated frequency 50Hz;
- 3 available frequency:5~50Hz;
- 4 protection class:IP54,insulation class: F, temperature rising class:B;
- 5 ambient temperature:-15~40C ;
- 6 continue working duty:S1;
- 7 altitude less than 1000m;
- 8 cooling with independence fan:C416;
- 9 connection perform the requirement of inverter;
- 10 first select 4 poles motor;

特殊电机

- 1 选用包括防爆电机, 辊道电机, 船用电机, 多速电机等特殊电机, 本公司提供IEC标准电机法兰接口, 接口尺寸见135-136页;
- 2 异频率, 异电压电机, 请联系本公司技术部;
- 3 使用环境温度不在-15~40℃范围内, 请联系本公司技术部;
- 4 更高的绝缘等级及防护等级, 请联系本公司技术部。

Customized Motor

- 1 others like explosion proof, roller motor, marine motor or multi-speed motor coupled by adaptor, the dimensions on page 135-136.
- 2 need different frequency and voltage, please contact us.
- 3 ambient temperature is out of -15~40C ,please contact us.
- 4 for higher insulation and protection class, please contact us.



安装位置

Mounting Position

减速机安装位置

Gear Unit Mounting Position

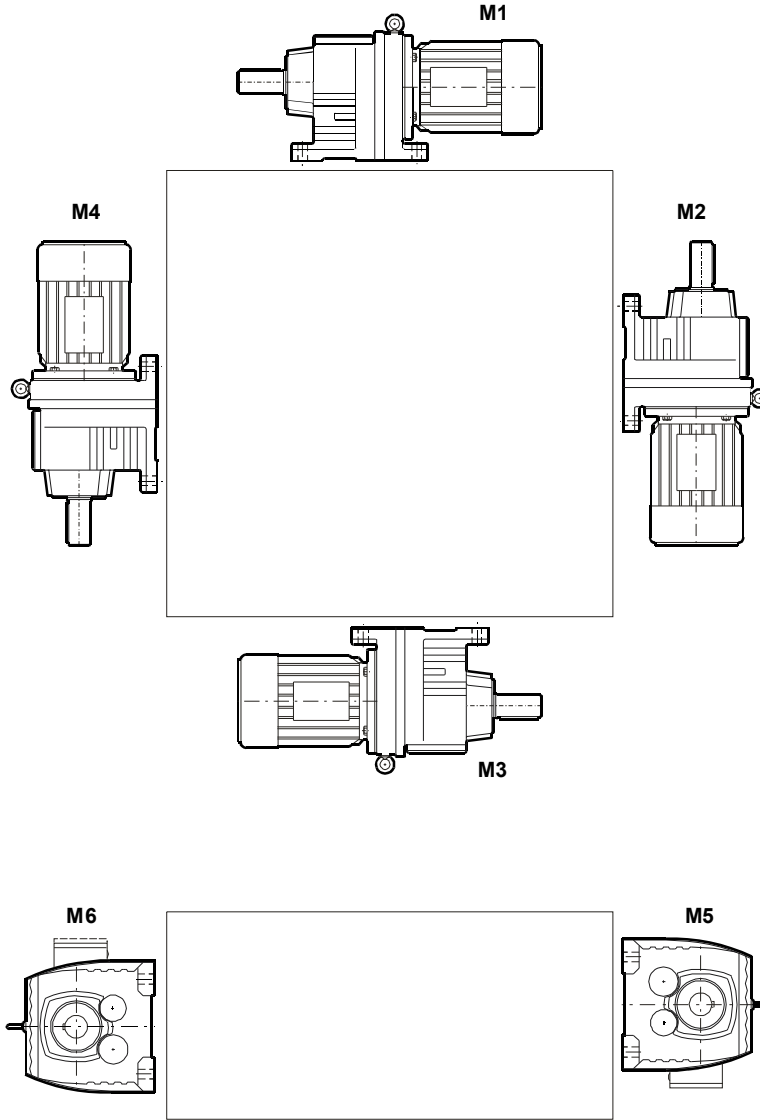

接线盒位置

Terminal Box Position

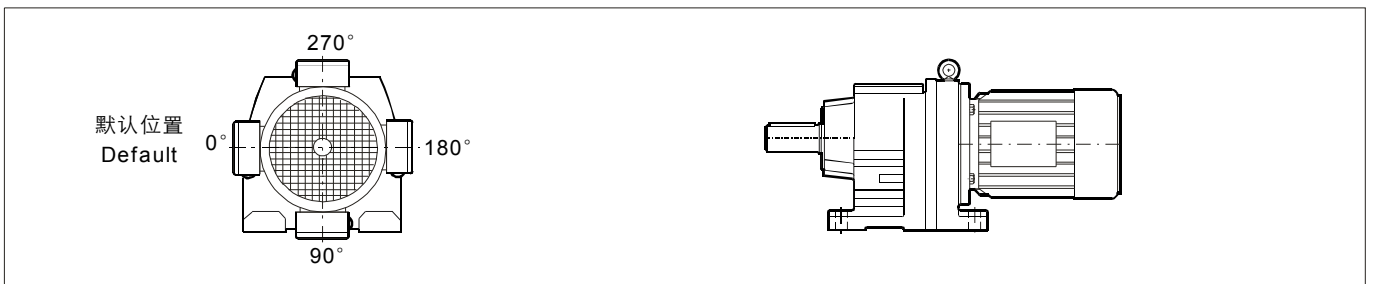



安装位置

Mounting Position

减速机安装位置

Gear Unit Mounting Position

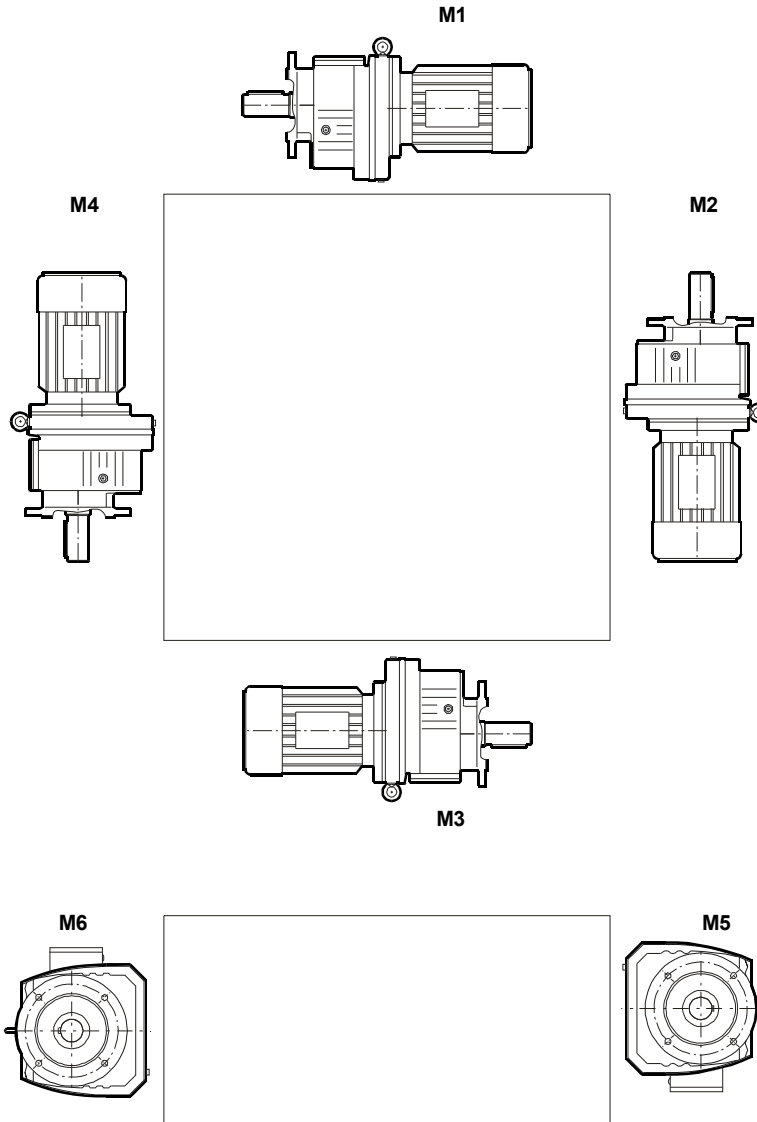

接线盒位置

Terminal box position

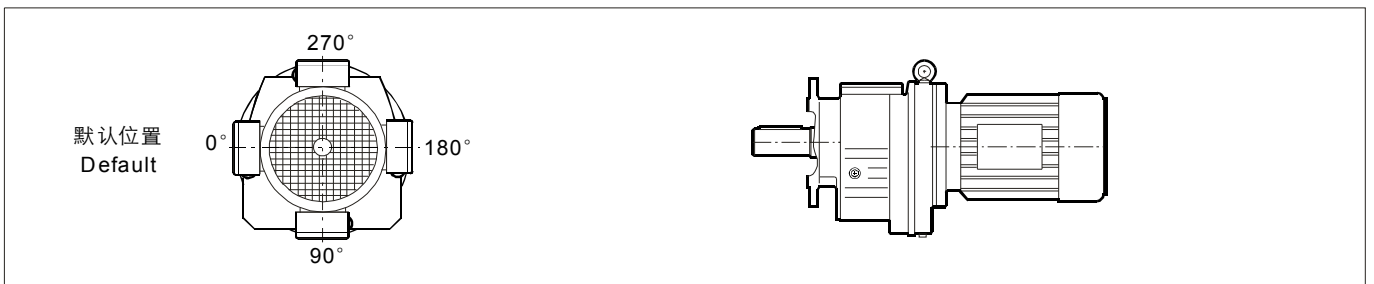



安装位置

Mounting Position

减速机安装位置

Gear Unit Mounting Position

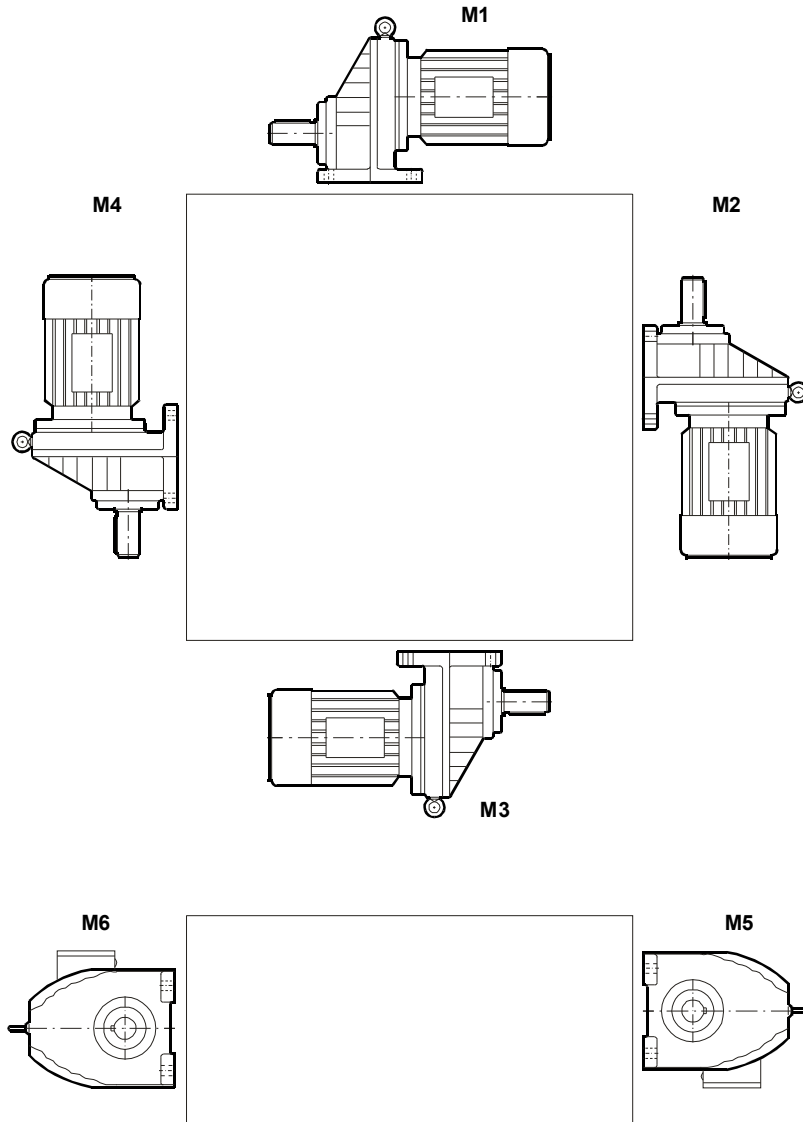

接线盒位置

Terminal box position

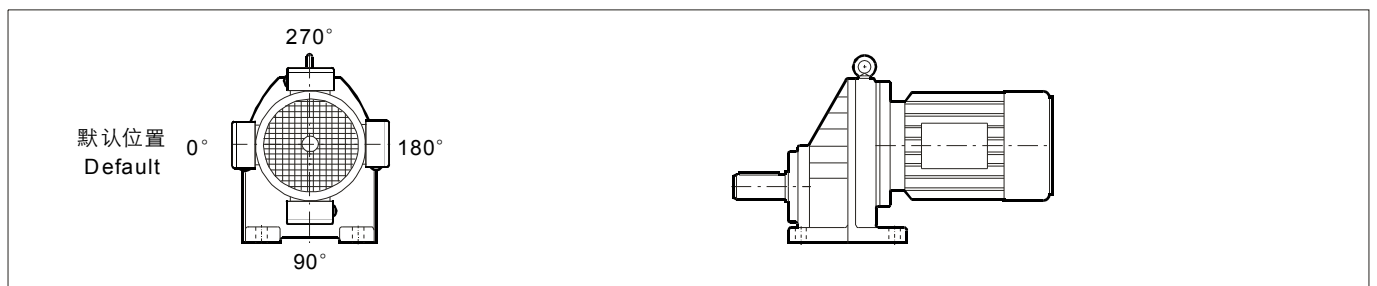



安装位置

Mounting Position

减速机安装位置

Gear Unit Mounting Position

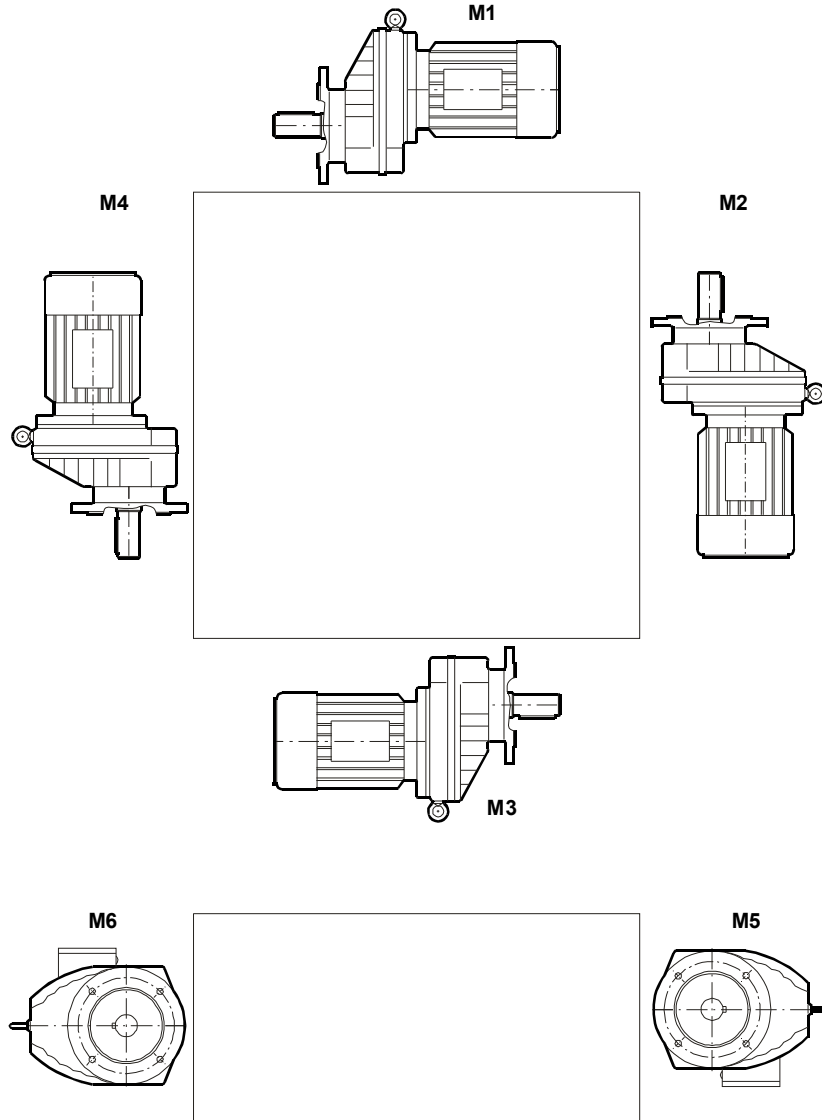

接线盒位置

Terminal box position

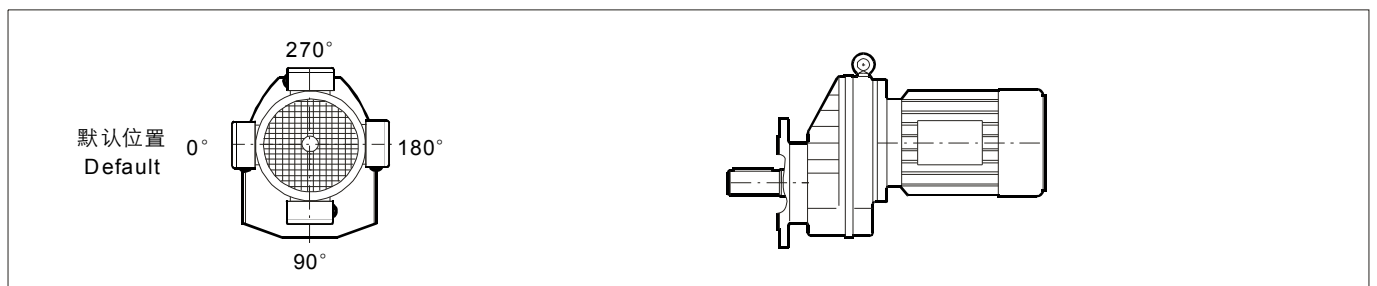



技术参数

Technical Data

符号意义

Key to Symbols

①
↓

$P_1 = 0.12 \text{ kW}$

NA rpm	M ₂ Nm	i	Fr _{2MAX} [N]	f _s	Type	Gear unit	Motor size	 Kg
0.06	13300	21342	62000	1.00				
0.08	11400	18210	65700	1.15				
0.09	9930	15923	67900	1.30				
0.10	8780	14075	69400	1.50				
0.11	7650	12344	70700	1.70				
0.12	6740	11143	71600	1.95	R	147 R77	63M1-4	420
0.14	6040	9743	72200	2.2	RF	147 R77	63M1-4	430
0.16	4830	8443	73100	2.7				
0.19	4180	7307	73400	3.1				
0.21	3690	6447	73700	3.5				
0.25	3190	5568	73900	4.1				
↑ ②	↑ ③	↑ ④	↑ ⑤	↑ ⑥	↑ ⑦	↑ ⑧	↑ ⑨	↑ ⑩

- 1 电机功率
- 2 输出转速
- 3 输出转矩
- 4 减速比
- 5 输出轴中最大点载荷
- 6 使用系数
- 7 减速机类型
- 8 减速机规格
- 9 电机型号
- 10 大概重量

- 1 motor power
- 2 output speed
- 3 output torque
- 4 transmission ratio
- 5 maximum load on middle output shaft
- 6 service factor
- 7 gear unit type
- 8 gear unit size
- 9 motor frame
- 10 approximate weight



技术参数

Technical Data

P ₁ = 0.12 kW								
NA rpm	M ₂ Nm	i	Fr ₂ MAX[N]	f _s	Type	Gear unit	Motor size	 Kg
0.06	13300	21342	62000	1.00				
0.08	11400	18210	65700	1.15				
0.09	9930	15923	67900	1.30				
0.10	8780	14075	69400	1.50				
0.11	7650	12344	70700	1.70				
0.12	6740	11143	71600	1.95	R	147 R77	63M1-4	420
0.14	6040	9743	72200	2.2	RF	147 R77	63M1-4	430
0.16	4830	8443	73100	2.7				
0.19	4180	7307	73400	3.1				
0.21	3690	6447	73700	3.5				
0.25	3190	5568	73900	4.1				
0.11	8060	12921	53300	1.00				
0.12	7260	11712	54900	1.10				
0.13	6390	10573	56400	1.25				
0.16	5030	8784	58400	1.60	R	137 R77	63M1-4	290
0.18	4090	7479	59400	1.95	RF	137 R77	63M1-4	310
0.21	4060	6559	59400	1.95				
0.24	3190	5834	60200	2.5				
0.27	3170	5116	60200	2.5				
0.18	4410	7583	28800	0.95				
0.20	3690	6743	32400	1.15				
0.23	3660	5914	32500	1.15				
0.27	2830	5168	35500	1.50	R	107 R77	63M1-4	200
0.31	2540	4435	36100	1.70	RF	107 R77	63M1-4	210
0.35	2270	3896	36500	1.90				
0.45	1880	3039	36900	2.3				
0.35	2470	3918	36200	1.75				
0.41	2110	3343	36700	2.0				
0.45	1910	3034	36900	2.3	R	107 R77	63M1-4	195
0.52	1670	2653	37100	2.6	RF	107 R77	63M1-4	200
0.61	1440	2280	37300	3.0				
0.67	1300	2067	37400	3.3				
0.30	3050	4559	17700	1.00	R	97 R57	63M1-4	130
0.34	2570	4004	23700	1.15	RF	97 R57	63M1-4	145
0.40	2270	3481	25200	1.30				
0.29	3240	4678	4840	0.95				
0.32	2980	4309	20400	1.00				
0.37	2560	3702	23700	1.15				
0.46	2080	3019	26100	1.45	R	97R57	63M1-4	125
0.52	1810	2668	27100	1.65	RF	97R57	63M1-4	145
0.61	1480	2245	27700	2.0				
0.68	1310	2016	27900	2.3				
0.80	1200	1733	28000	2.5				



技术参数

Technical Data

P ₁ = 0.12 kW									
N _A rpm	M ₂ Nm	i	Fr ₂ MAX[N]	f _s	Type	Gear unit	Motor size	 Kg	
0.45	2120	3065	25900	1.40					
0.51	1880	2722	26800	1.60					
0.60	1590	2311	27500	1.90					
0.66	1430	2078	27700	2.1	R	97 R57	63M1-4	130	
0.76	1240	1823	28000	2.4	RF		63M1-4	145	
0.87	1070	1583	28200	2.8					
0.99	910	1396	28300	3.3					
1.1	775	1228	28400	3.9					
0.48	1770	2873	15200	0.90	R		87 R57	63M1-4	86
0.70	1300	1961	18500	1.20	RF		87 R57	63M1-4	93
0.53	1790	2595	15000	0.85					
0.65	1430	2129	17700	1.10	R	87 R57	63M1-4	85	
0.72	1270	1930	18600	1.20	RF	87 R57	63M1-4	92	
0.80	1120	1733	19300	1.40					
0.79	1150	1737	19200	1.35					
0.91	1010	1524	19800	1.55					
1.1	810	1303	20000	1.90					
1.2	710	1143	20000	2.2	R	87 R57	63M1-4	85	
1.6	585	885	20000	2.7	RF	87 R57	63M1-4	92	
1.8	515	776	20000	3.0					
2.0	450	685	20000	3.4					
2.3	360	599	20000	4.3					
1.1	940	1303	8660	0.85					
1.2	800	1124	10100	1.05	R	77 R37	63M1-4	45	
1.3	740	1047	10600	1.10	RF	77 R37	63M1-4	51	
1.5	640	915	11300	1.30					
1.1	820	1218	9910	1.00					
1.3	740	1084	10600	1.10					
1.5	665	940	11200	1.25	R	77 R37	63M1-4	46	
1.7	525	821	12000	1.55	RF	77 R37	63M1-4	52	
1.9	480	731	12200	1.70					
2.1	460	646	12300	1.80					
2.6	380	520	12600	2.2					
3.1	325	451	12700	2.5	R	77 R37	63M1-4	45	
3.3	300	422	12800	2.7	RF	77 R37	63M1-4	51	
3.8	255	365	12900	3.2					
1.6	630	891	7190	0.95					
1.9	505	730	8530	1.20	R	67 R37	63M1-4	40	
2.1	440	644	9060	1.35	RF	67 R37	63M1-4	43	
2.4	385	571	9430	1.55					
2.8	320	486	9790	1.85					



技术参数

Technical Data

P ₁ = 0.12 kW								
NA rpm	M ₂ Nm	i	Fr ₂ MAX[N]	f _s	Type	Gear unit	Motor size	 Kg
1.7	590	836	7670	1.00				
1.8	495	750	8630	1.20				
2.1	440	646	9050	1.35	R	67 R37	63M1-4	41
2.4	400	574	9330	1.50	RF	67 R37	63M1-4	44
2.8	345	495	9660	1.75				
3.1	285	438	9940	2.1				
1.8	550	782	4650	0.80				
2.0	455	678	7070	1.00				
2.3	415	604	7260	1.10	R	57 R37	63M1-4	34
2.6	375	537	7400	1.20	RF	57 R37	63M1-4	38
2.9	330	471	7550	1.35				
3.9	245	357	7770	1.85				
4.3	215	319	7830	2.1				
3.8	260	359	7730	1.75				
4.3	235	324	7790	1.95				
4.8	205	290	7840	2.2	R	57 R37	63M1-4	33
5.3	185	262	7880	2.4	RF	57 R37	63M1-4	37
5.6	171	246	7900	2.6				
6.3	150	220	7930	3.0				
2.7	345	510	4360	0.85				
3.2	285	436	5490	1.05	R	47 R37	63M1-4	28
3.4	265	408	5590	1.10	RF	47 R37	63M1-4	28
4.0	220	344	5790	1.35				
2.8	365	502	3020	0.80				
3.2	315	429	5350	0.95				
3.7	270	372	5580	1.10				
4.0	250	348	5670	1.20	R	47 R37	63M1-4	28
4.6	210	301	5810	1.40	RF	47 R37	63M1-4	28
5.4	177	255	5930	1.70				
6.0	156	228	5980	1.95				
7.1	130	195	6040	2.3				
4.1	225	338	4570	0.90				
4.7	210	296	4790	0.95				
5.3	184	259	5130	1.10	R	37 R17	63M1-4	17
6.0	163	228	5360	1.25	RF	37 R17	63M1-4	19
6.9	140	199	5550	1.40				
8.0	123	172	5680	1.65				
4.2	240	328	3730	0.85				
4.8	205	289	4880	1.00				
5.2	192	265	5040	1.05	R	37 R17	63M1-4	17
6.1	156	226	5410	1.30	RF	37 R17	63M1-4	18
6.8	144	202	5530	1.40				
7.7	125	179	5660	1.60				



技术参数

Technical Data

P ₁ = 0.12 kW								
NA rpm	M ₂ Nm	i	Fr ₂ MAX[N]	f _s	Type	Gear unit	Motor size	 Kg
6.0	158	229	4090	0.80				
6.9	138	200	4200	0.95	R	27 R17	63M1-4	11
7.8	121	177	4270	1.05	RF	27 R17	63M1-4	11
8.3	116	166	4290	1.10				
6.1	157	227	4100	0.85				
6.8	144	203	4170	0.90	R	27 R17	63M1-4	11
7.7	125	179	4260	1.05	RF	27 R17	63M1-4	11
8.8	106	156	4330	1.25				
4.6	250	195.24	12900	3.3	R	77	Y7116	37
5.4	210	166.59	13000	3.9	RF	77	Y7116	43
6.2	186	145.67	13000	4.4				
4.5	255	199.81	10100	2.4				
4.9	235	184.07	10100	2.6				
5.7	200	158.14	10300	3.0	R	67	Y7116	30
6.5	175	137.67	10300	3.4	RF	67	Y7116	33
7.0	164	128.97	10400	3.7				
7.9	145	113.94	10400	4.1				
6.9	166	199.81	10300	3.6	R	67	63M1-4	30
7.5	153	184.07	10400	3.9	RF	67	63M1-4	33
4.8	240	186.89	7780	1.90				
5.2	220	172.17	7820	2.1				
6.1	188	147.92	7870	2.4	R	57	Y7116	23
7.0	164	128.77	7910	2.7	RF	57	Y7116	27
7.5	154	120.63	7920	2.9				
8.4	136	106.58	7950	3.3				
9.1	126	98.99	7960	3.6				
7.4	155	186.89	7920	2.9				
8.0	143	172.17	7940	3.2	R	57	63M1-4	23
9.3	123	147.92	7960	3.7	RF	57	63M1-4	27
11	107	128.77	7980	4.2				
5.1	225	176.88	5760	1.35				
5.5	210	162.94	5830	1.45	R	47	Y7116	18
6.4	178	139.99	5920	1.70	RF	47	Y7116	18
7.4	155	121.87	5980	1.95				
7.8	147	176.88	6000	2.0				
8.5	135	162.94	6030	2.2				
9.9	116	139.99	6070	2.6	R	47	63M1-4	18
11	101	121.87	6100	3.0	RF	47	63M1-4	18
12	95	114.17	6110	3.2				
14	84	100.86	6120	3.6				
15	78	93.68	6130	3.9				



技术参数

Technical Data

P ₁ = 0.12 kW								
NA rpm	M ₂ Nm	i	Fr ₂ MAX[N]	f _s	Type	Gear unit	Motor size	 Kg
6.7	172	134.82	5270	1.15				
7.3	157	123.66	5410	1.25				
8.6	134	105.28	5600	1.50	R	37	Y7116	14
9.9	116	90.77	5730	1.75	RF	37	Y7116	16
11	108	84.61	5770	1.85				
12	94	73.96	5850	2.1				
<hr/>								
10	112	134.82	5750	1.80				
11	103	123.66	5800	1.95				
13	87	105.28	5880	2.3	R	37	63M1-4	14
15	75	90.77	5930	2.7	RF	37	63M1-4	16
16	70	84.61	5950	2.8				
19	61	73.96	5980	3.3				
<hr/>								
7.3	158	123.91	4090	0.80				
8.5	134	105.49	4210	0.95				
9.9	116	90.96	4300	1.10	R	27	Y7116	8.3
11	108	84.78	4330	1.20	RF	27	Y7116	8.2
12	94	74.11	4370	1.40				
<hr/>								
10	112	135.09	4310	1.15				
11	103	123.91	4340	1.25				
13	88	105.49	4390	1.50				
15	76	90.96	4430	1.70				
16	70	84.78	4440	1.85	R	27	63M1-4	8.3
19	62	74.11	4460	2.1	RF	27	63M1-4	8.2
20	58	69.47	4470	2.3				
23	51	61.30	4400	2.6				
25	46	55.87	4280	2.8				
29	40	48.17	4090	3.3				
31	37	44.90	4000	3.5				
<hr/>								
11	104	81.64	1300	0.80				
13	90	70.39	1470	0.95				
14	84	65.61	1860	1.00	R	17	Y7116	7.6
16	73	57.35	2430	1.15	RF	17	Y7116	7.5
17	68	53.76	2500	1.25				
19	60	47.44	2500	1.40				
<hr/>								
17	68	81.64	2500	1.25				
20	58	70.39	2500	1.45				
21	55	65.61	2500	1.55				
24	48	57.35	2500	1.80				
26	45	53.76	2500	1.90	R	17	63M1-4	7.6
29	39	47.44	2500	2.2	RF	17	63M1-4	7.5
31	37	44.18	2500	2.3				
36	32	38.61	2430	2.7				
38	30	36.20	2390	2.8				
43	27	31.94	2310	3.2				



技术参数

Technical Data

P₁ = 0.12 kW								
--------------------------------	--	--	--	--	--	--	--	--

N _A rpm	M ₂ Nm	i	Fr ₂ MAX[N]	f _s	Type	Gear unit	Motor size	Kg
49	24	28.32	2230	3.6	R	17	63M1-4	7.6
57	20	24.07	2130	4.3	RF	17	63M1-4	7.5
227	5.0	6.07	4270	8.6				
267	4.3	5.18	4050	17	RX	67	63M1-4	16
305	3.8	4.53	3870	22	RXF	67	63M1-4	20
321	3.6	4.30	3810	22				
251	4.6	5.50	3360	8.5				
272	4.2	5.07	3270	8.6				
317	3.6	4.35	3120	19				
364	3.1	3.79	2980	22				
389	2.9	3.55	2910	24				
440	2.6	3.14	2800	25	RX	57	63M1-4	14
474	2.4	2.91	2730	28	RXF	57	63M1-4	16
523	2.2	2.64	2640	31				
582	2.0	2.37	2550	35				
676	1.7	2.04	2430	41				
719	1.6	1.92	2380	43				
835	1.4	1.65	2260	49				

P₁ = 0.18 kW								
--------------------------------	--	--	--	--	--	--	--	--

0.09	15000	14075	50900	0.85				
0.11	13100	12344	62500	1.00	R	147 R77	63M2-4	420
0.12	11600	11143	65200	1.10	RF	147 R77	63M2-4	430
0.14	10300	9743	67300	1.25				
0.16	8550	8443	69700	1.50				
0.18	7400	7307	70900	1.75				
0.20	6530	6447	71800	2.0				
0.24	5640	5568	72500	2.3	R	147 R77	63M2-4	420
0.27	5150	4926	72800	2.5	RF	147 R77	63M2-4	430
0.31	4420	4325	73300	2.9				
0.35	3920	3754	73600	3.3				
0.40	3380	3302	73800	3.9				
0.15	8900	8784	50100	0.90				
0.18	7390	7479	54600	1.10				
0.20	6950	6559	55500	1.15				
0.23	5770	5834	57400	1.40	R	137 R77	63M2-4	290
0.26	5420	5116	57900	1.50	RF	137 R77	63M2-4	310
0.30	4520	4464	59000	1.75				
0.34	3980	3928	59500	2.0				
0.28	5060	4709	58300	1.60	R	137 R77	63M2-4	280
0.33	4320	4018	59200	1.85	RF	137 R77	63M2-4	300
0.38	3780	3514	59700	2.1				



技术参数

Technical Data

P ₁ = 0.18 kW								
NA rpm	M ₂ Nm	i	Fr ₂ MAX[N]	f _s	Type	Gear unit	Motor size	 Kg
0.40	3590	3338	59900	2.2	R	137 R77	63M2-4	280
0.45	3150	2929	60200	2.5	RF	137 R77	63M2-4	300
0.30	4490	4435	28400	0.95	R	107 R77	63M2-4	200
0.34	3980	3896	31100	1.10	RF	107 R77	63M2-4	210
0.43	3220	3039	34200	1.35				
0.34	4210	3918	29900	1.00				
0.39	3590	3343	32800	1.20				
0.44	3260	3034	34100	1.30	R	107 R77	63M2-4	195
0.50	2850	2653	35400	1.50	RF	107 R77	63M2-4	200
0.58	2450	2280	36200	1.75				
0.64	2220	2067	36500	1.95				
0.66	2100	1987	36700	2.1				
0.72	1870	1827	36900	2.3	R	107 R77	63M2-4	200
0.83	1600	1599	37200	2.7	RF	107 R77	63M2-4	205
0.94	1440	1400	37300	3.0				
1.1	1230	1226	37400	3.5				
0.49	3000	2668	20000	1.00				
0.59	2480	2245	24200	1.20				
0.65	2210	2016	25500	1.35				
0.76	1970	1733	26500	1.50				
0.81	1840	1623	27000	1.65				
0.92	1610	1434	27500	1.85	R	97 R57	63M2-4	125
1.1	1330	1207	27900	2.3	RF	97 R57	63M2-4	145
1.2	1190	1084	28000	2.5				
1.4	1000	934	28200	3.0				
1.5	940	878	28300	3.2				
1.8	790	755	28400	3.8				
0.49	3090	2722	15900	0.95	R	97 R57	63M2-4	130
0.57	2620	2311	23400	1.15	RF	97 R57	63M2-4	145
0.64	2360	2078	24800	1.25				
0.89	1690	1489	15900	0.90				
0.95	1580	1395	16700	1.00				
1.1	1380	1232	18000	1.10	R	87 R57	63M2-4	85
1.2	1280	1145	18600	1.20	RF	87 R57	63M2-4	92
1.3	1150	1037	19200	1.35				
1.4	1020	931	19800	1.50				
1.7	860	802	20000	1.80				
0.87	1680	1524	15900	0.90				
1.0	1390	1303	17900	1.10	R	87 R57	63M2-4	85
1.2	1220	1143	18900	1.25	RF	87 R57	63M2-4	92
1.5	980	885	19900	1.60				
1.7	860	776	20000	1.80				



技术参数

Technical Data

P ₁ = 0.18 kW								
NA rpm	M ₂ Nm	i	Fr ₂ MAX[N]	f _s	Type	Gear unit	Motor size	 Kg
1.5	980	858	5830	0.85				
1.7	850	757	9590	0.95	R	77 R37	63M2-4	45
2.0	750	671	10500	1.10	RF	77 R37	63M2-4	51
2.3	630	571	11400	1.30				
1.6	890	821	9230	0.90				
1.8	800	731	10100	1.00				
2.0	745	646	10500	1.10				
2.4	645	560	11300	1.25	R	77 R37	63M2-4	46
2.7	550	488	11800	1.50	RF	77 R37	63M2-4	52
3.0	490	436	12100	1.70				
3.5	420	373	12400	1.95				
4.0	370	327	12600	2.2				
4.6	330	289	12700	2.5				
2.3	640	571	7060	0.95	R	67 R37	63M2-4	40
2.7	535	486	8250	1.10	RF	67 R37	63M2-4	43
2.3	655	574	5820	0.90				
2.7	565	495	7950	1.05				
3.0	480	438	8740	1.25	R	67 R37	63M2-4	41
3.4	425	388	9160	1.40	RF	67 R37	63M2-4	44
3.8	395	344	9380	1.55				
4.5	320	294	9800	1.90				
5.1	290	261	9920	2.1				
2.9	500	454	6650	0.90	R	57 R37	63M2-4	33
3.2	455	410	7090	1.00	RF	57 R37	63M2-4	37
2.8	540	471	5250	0.85				
3.7	405	357	7300	1.10				
4.1	355	319	7460	1.25	R	57 R37	63M2-4	34
4.8	300	273	7630	1.50	RF	57 R37	63M2-4	38
5.5	260	241	7730	1.75				
6.1	235	215	7790	1.95				
3.7	420	359	7230	1.05				
4.1	380	324	7380	1.20				
4.5	335	290	7530	1.35				
5.0	305	262	7620	1.50	R	57 R37	63M2-4	33
5.4	280	246	7680	1.60	RF	57 R37	63M2-4	37
6.0	250	220	7750	1.80				
7.0	210	188	7830	2.1				
8.3	177	159	7890	2.6				
4.4	350	301	4150	0.85				
5.2	290	255	5460	1.05	R	47 R37	63M2-4	28
5.8	260	228	5630	1.15	RF	47 R37	63M2-4	28
6.8	220	195	5790	1.40				



技术参数

Technical Data

P ₁ = 0.18 kW									
NA rpm	M ₂ Nm	i	Fr ₂ MAX[N]	f _s	Type	Gear unit	Motor size	Kg	
6.6	230	199	4510	0.85	R	37 R17	63M2-4	17	
7.7	199	172	4960	1.00	RF	37 R17	63M2-4	19	
8.8	173	150	5260	1.15					
6.5	235	202	4050	0.85	R	37 R17	63M2-4	17	
7.4	205	179	4870	0.95	RF	37 R17	63M2-4	18	
8.5	176	156	5230	1.15					
9.4	157	141	4100	0.85					
11	139	124	4190	0.95	R	27 R17	63M2-4	11	
12	125	110	4260	1.05	RF	27 R17	63M2-4	11	
14	105	94	4340	1.25					
9.8	152	135	4120	0.85					
11	139	118	4190	0.95	R	27 R17	63M2-4	11	
13	121	104	4270	1.10	RF	27 R17	63M2-4	11	
15	105	90	4340	1.25					
4.5	385	195.24	12500	2.1	R	77	63M2-4	38	
5.2	330	166.59	12700	2.5	RF	77	63M2-4	43	
6.0	290	145.67	12800	2.9	R	77	63M2-4	38	
6.3	275	138.39	12900	3.0	RF	77	63M2-4	43	
7.2	240	121.42	12900	3.4					
6.8	255	195.24	12900	3.2					
7.9	215	166.59	13000	3.8	R	77	63M2-4	37	
9.1	190	145.67	13000	4.3	RF	77	63M2-4	43	
9.5	180	138.39	13000	4.6					
4.4	395	199.81	9370	1.50					
4.7	365	184.07	9560	1.65					
5.5	310	158.14	9830	1.90					
6.3	270	137.67	10000	2.2					
6.8	255	128.97	10100	2.4	R	67	63M2-4	31	
7.6	225	113.94	10200	2.7	RF	67	63M2-4	34	
8.2	210	105.83	10200	2.9					
9.1	190	95.91	10300	3.2					
10	170	86.11	10300	3.5					
12	147	74.17	10400	4.1					
12	138	69.75	10400	4.4					
6.6	260	199.81	10100	2.3					
7.2	240	184.07	10100	2.5					
8.3	205	158.14	10200	2.9	R	67	63M2-4	30	
9.6	179	137.67	10300	3.4	RF	67	63M2-4	33	
10	168	128.97	10300	3.6					
12	148	113.94	10400	4.0					
12	138	105.83	10400	4.4					



技术参数

Technical Data

P ₁ = 0.18 kW								
NA rpm	M ₂ Nm	i	Fr ₂ MAX[N]	f _s	Type	Gear unit	Motor size	 Kg
4.7	370	186.89	7420	1.20				
5.0	340	172.17	7510	1.30	R	57	71M1-6	24
5.9	290	147.92	7650	1.55	RF	57	71M1-6	27
6.8	255	128.77	7740	1.75				
7.2	240	120.63	7780	1.90				
7.1	245	186.89	7770	1.85				
7.7	225	172.17	7810	2.0				
8.9	193	147.92	7870	2.3				
10	168	128.77	7900	2.7	R	57	63M2-4	23
11	157	120.63	7920	2.9	RF	57	63M2-4	27
12	139	106.58	7940	3.2				
13	129	98.99	7950	3.5				
15	117	89.71	7970	3.9				
7.5	230	176.88	5740	1.30				
8.1	210	162.94	5810	1.40				
9.4	182	139.99	5910	1.65				
11	159	121.87	5980	1.90	R	47	63M2-4	18
12	149	114.17	6000	2.0	RF	47	63M2-4	18
13	131	100.86	6040	2.3				
14	122	93.68	6060	2.5				
16	111	84.90	6080	2.7				
17	99	76.23	6100	3.0				
7.0	245	123.66	3060	0.80				
8.3	210	105.28	4840	0.95	R	37	63M2-4	15
9.6	179	90.77	5190	1.10	RF	37	63M2-4	16
10	167	84.61	5310	1.20				
9.8	176	134.82	5230	1.15				
11	161	123.66	5370	1.25				
13	137	105.28	5580	1.45				
15	118	90.77	5710	1.70				
16	110	84.61	5760	1.80	R	37	63M2-4	14
18	96	73.96	5840	2.1	RF	37	63M2-4	16
19	90	69.33	5870	2.2				
22	80	61.18	5920	2.5				
24	73	55.76	5940	2.8				
27	63	48.08	5960	3.2				
11	161	123.91	4070	0.80				
13	137	105.49	4200	0.95				
15	118	90.96	4280	1.10				
16	110	84.78	4320	1.20	R	27	63M2-4	8.3
18	97	74.11	4370	1.35	RF	27	63M2-4	8.2
19	91	69.47	4380	1.45				
22	80	61.30	4320	1.65				
24	73	55.87	4210	1.80				



技术参数

Technical Data

P ₁ = 0.18 kW								
NA rpm	M ₂ Nm	i	Fr ₂ MAX[N]	f _s	Type	Gear unit	Motor size	 Kg
27	63	48.17	4040	2.1				
29	59	44.90	3960	2.2				
34	51	39.25	3810	2.5	R	27	63M2-4	8.3
36	48	36.79	3740	2.7	RF	27	63M2-4	8.2
41	42	32.47	3610	3.1				
46	38	28.78	3480	3.5				
54	32	24.47	3310	4.1				
47	37	28.37	3470	3.5				
51	34	26.09	3380	3.8				
59	29	22.32	3220	4.5	R	27	63M2-4	8.0
68	25	19.35	3090	5.2	RF	27	63M2-4	7.9
73	24	18.08	3020	5.5				
84	20	15.63	2890	6.4				
99	17	13.28	2750	7.5				
16	106	81.64	1330	0.80				
19	92	70.39	1330	0.95				
20	85	65.61	1740	1.00				
23	75	57.35	2350	1.15				
25	70	53.76	2500	1.20				
28	62	47.44	2450	1.40	R	17	63M2-4	7.6
30	58	44.18	2410	1.50	RF	17	63M2-4	7.5
34	50	38.61	2340	1.70				
36	47	36.20	2300	1.80				
41	42	31.94	2240	2.0				
47	37	28.32	2170	2.3				
55	31	24.07	2080	2.7				
52	33	25.23	2110	2.6				
57	30	23.15	2060	2.8	R	17	63M2-4	7.3
67	26	19.71	1970	3.3	RF	17	63M2-4	7.2
78	22	16.99	1890	3.9				
143	12	6.07	4940	3.6				
168	10	5.18	4690	7.4	RX	67	71M1-6	17
192	8.9	4.53	4490	9.2	RXF	67	71M1-6	21
202	8.5	4.30	4410	9.4				
218	7.9	6.07	4310	5.4				
255	6.7	5.18	4090	11				
292	5.9	4.53	3920	14				
307	5.6	4.30	3850	14				
350	4.9	3.77	3690	18	RX	67	63M2-4	16
413	4.2	3.20	3500	24	RXF	67	63M2-4	20
457	3.8	2.89	3380	28				
519	3.3	2.54	3240	36				
550	3.1	2.40	3180	40				
646	2.7	2.04	3020	50				



技术参数

Technical Data

P₁ = 0.18 kW								
--------------------------------	--	--	--	--	--	--	--	--

N _A rpm	M ₂ Nm	i	Fr ₂ MAX[N]	f _s	Type	Gear unit	Motor size	Kg
158	11	5.50	3880	3.6				
172	10	5.07	3780	3.6	RX	57	71M1-6	14
200	8.6	4.35	3600	7.9	RXF	57	71M1-6	16
230	7.5	3.79	3440	9.2				
<hr/>								
240	7.2	5.50	3400	5.4				
261	6.6	5.07	3310	5.5				
303	5.7	4.35	3150	12				
348	4.9	3.79	3010	14				
372	4.6	3.55	2950	15				
421	4.1	3.14	2830	16	RX	57	63M2-4	14
453	3.8	2.91	2760	18	RXF	57	63M2-4	16
500	3.4	2.64	2670	20				
557	3.1	2.37	2580	22				
647	2.7	2.04	2460	26				
688	2.5	1.92	2410	28				
799	2.2	1.65	2290	31				

P₁ = 0.25 kW								
--------------------------------	--	--	--	--	--	--	--	--

0.13	15200	9743	48200	0.85				
0.15	12800	8443	63100	1.00				
0.18	11000	7307	66200	1.20				
0.20	9740	6447	68100	1.35				
0.23	8410	5568	69800	1.55	R	147 R77	71M1-4	420
0.26	7600	4926	70700	1.70	RF	147 R77	71M1-4	430
0.30	6570	4325	71700	2.0				
0.35	5790	3754	72400	2.3				
0.39	5020	3302	72900	2.6				
0.45	4380	2898	73300	3.0				
<hr/>								
0.22	8670	5834	51100	0.90				
0.25	7970	5116	53500	1.00	R	137 R77	71M1-4	290
0.29	6740	4464	55800	1.20	RF	137 R77	71M1-4	310
0.33	5930	3928	57100	1.35				
<hr/>								
0.28	7430	4709	54600	1.10				
0.32	6340	4018	56500	1.25				
0.37	5550	3514	57700	1.45	R	137 R77	71M1-4	280
0.39	5270	3338	58100	1.50	RF	137 R77	71M1-4	300
0.44	4620	2929	58900	1.75				
<hr/>								
0.49	4190	2658	59300	1.90				
0.54	3800	2412	59700	2.1				
0.63	3270	2073	60100	2.5	R	137 R77	71M1-4	290
0.71	2810	1839	60500	2.8	RF	137 R77	71M1-4	310
0.93	2180	1397	60800	3.7				
1.1	1890	1226	61000	4.2				



技术参数

Technical Data

P ₁ = 0.25 kW								
N _A rpm	M ₂ Nm	i	Fr ₂ MAX[N]	f _s	Type	Gear unit	Motor size	 Kg
0.43	4730	3039	25600	0.90	R	107 R77	71M1-4	205
					RF	107 R77	71M1-4	210
0.43	4790	3034	23600	0.90	R	107 R77	71M1-4	195
					RF	107 R77	71M1-4	200
0.65	3100	1987	34600	1.40	R	107 R77	71M1-4	200
0.71	2790	1827	35600	1.55				
0.81	2410	1599	36300	1.80				
0.93	2140	1400	36600	2.0				
1.1	1840	1226	36900	2.3				
1.4	1440	939	37300	3.0				
1.6	1240	822	37400	3.5				
0.75	2840	1733	22000	1.05	R	97 R57	71M1-4	125
0.80	2660	1623	23200	1.15	RF	97 R57	71M1-4	145
0.71	2960	1823	21100	1.00	R	97 R57	71M1-4	130
0.82	2570	1583	23700	1.15				
0.93	2230	1396	25400	1.35				
1.1	1940	1228	26600	1.55				
1.2	1750	1069	27300	1.70				
1.4	1530	938	27600	1.95				
1.6	1300	824	27900	2.3				
1.8	1160	737	28100	2.6				
2.1	1000	632	28200	3.0				
1.1	1850	1145	10700	0.85	R	87 R57	71M1-4	85
1.2	1670	1037	16000	0.95	RF	87 R57	71M1-4	93
1.4	1490	931	17400	1.05				
1.6	1270	802	18600	1.20				
1.1	1800	1143	14700	0.85	R	87 R57	71M1-4	86
1.5	1420	885	17800	1.10				
1.7	1250	776	18700	1.25				
1.9	1100	685	19400	1.40				
2.2	930	599	20000	1.65				
2.5	820	525	20000	1.90				
2.9	715	456	20000	2.2				
4.9	415	268	20000	3.7				
2.3	920	571	8910	0.90	R	77 R37	71M1-4	46
					RF	77 R37	71M1-4	52
2.3	930	560	8780	0.90	R	77 R37	71M1-4	47
2.7	795	488	10100	1.05				
3.0	705	436	10900	1.15				
3.5	610	373	11500	1.35				
4.0	535	327	11900	1.55				
4.5	475	289	12200	1.75				



技术参数

Technical Data

P ₁ = 0.25 kW								
NA rpm	M ₂ Nm	i	Fr ₂ MAX[N]	f _s	Type	Gear unit	Motor size	 Kg
5.0	425	260	12400	1.95	R	77 R37	71M1-4	47
5.8	355	224	12600	2.3	RF	77 R37	71M1-4	53
3.4	620	388	7290	0.95				
3.8	565	344	7950	1.05				
4.4	465	294	8870	1.30				
5.0	425	261	9180	1.40	R	67 R37	71M1-4	41
5.5	380	234	9460	1.60	RF	67 R37	71M1-4	45
6.5	320	200	9780	1.85				
7.4	280	176	9980	2.2				
8.2	250	158	10100	2.4				
3.4	645	384	6960	0.95				
3.6	600	359	7550	1.00				
4.2	515	310	8430	1.15				
4.9	435	264	9100	1.40	R	67 R37	71M1-4	41
5.5	385	235	9420	1.55	RF	67 R37	71M1-4	44
6.5	325	201	9750	1.85				
7.2	295	181	9910	2.0				
4.1	520	319	6050	0.85				
4.8	440	273	7160	1.05				
5.4	380	241	7380	1.20				
6.0	340	215	7510	1.30	R	57 R37	71M1-4	35
7.0	300	187	7630	1.50	RF	57 R37	71M1-4	38
7.9	260	164	7730	1.75				
9.2	225	142	7800	2.0				
4.0	545	324	4980	0.85				
4.5	485	290	6950	0.95				
5.0	435	262	7160	1.05	R	57 R37	71M1-4	34
5.3	405	246	7280	1.10	RF	57 R37	71M1-4	37
5.9	360	220	7450	1.25				
5.7	375	228	2440	0.80				
6.7	315	195	5320	0.95	R	47 R37	71M1-4	29
7.1	295	182	5440	1.00	RF	47 R37	71M1-4	29
8.5	245	154	5680	1.20				
8.7	250	150	2540	0.80				
10	210	130	4790	0.95				
10	200	124	4930	1.00	R	37 R17	71M1-4	18
12	178	110	5200	1.10	RF	37 R17	71M1-4	19
14	152	94	5460	1.30				
9.7	220	135	4660	0.90				
10	215	127	4770	0.95	R	37 R17	71M1-4	18
13	174	104	5250	1.15	RF	37 R17	71M1-4	19
14	150	90	5470	1.35				



技术参数

Technical Data

P ₁ = 0.25 kW								
NA rpm	M ₂ Nm	i	Fr ₂ MAX[N]	f _s	Type	Gear unit	Motor size	 Kg
2.4	1020	289.74	28200	3.0				
2.7	900	255.71	28300	3.3	R	97	71M2-6	110
2.8	850	241.25	28400	3.5	RF	97	71M2-6	125
3.1	760	216.28	28400	4.0				
2.8	870	246.54	20000	1.8				
3.1	760	216.54	20000	2.0	R	87	80M2-8	68
3.3	720	205.71	20000	2.2	RF	87	80M2-8	75
3.7	640	181.77	20000	2.4				
4.1	585	166.59	11600	1.40				
4.7	510	145.67	12000	1.60	R	77	80M2-8	42
4.9	485	138.39	12100	1.70	RF	77	80M2-8	48
5.6	425	121.42	12400	1.90				
4.5	530	195.24	11900	1.55	R	77	71M2-6	38
5.3	450	166.59	12300	1.80	RF	77	71M2-6	44
6.0	395	145.67	12500	2.1				
6.7	360	195.24	12600	2.3				
7.8	305	166.59	12800	2.7	R	77	71M2-4	38
8.9	270	145.67	12900	3.1	RF	77	71M2-4	43
9.4	255	138.39	12900	3.2				
11	225	121.42	13000	3.7				
4.3	555	158.14	8060	1.10				
4.9	485	137.67	8730	1.25	R	67	80M2-8	35
5.3	455	128.97	8970	1.35	RF	67	80M2-8	38
6.0	400	113.94	9340	1.50				
4.4	540	199.81	8190	1.10				
4.8	500	184.07	8590	1.20				
5.6	430	158.14	9140	1.40				
6.4	375	137.67	9500	1.60	R	67	71M2-6	32
6.8	350	128.97	9630	1.70	RF	67	71M2-6	35
7.7	310	113.94	9840	1.95				
8.3	285	105.83	9940	2.1				
6.5	365	199.81	9540	1.65				
7.1	340	184.07	9700	1.80				
8.2	290	158.14	9930	2.1				
9.4	255	137.67	10100	2.4	R	67	71M2-4	31
10	235	128.97	10100	2.5	RF	67	71M2-4	34
11	210	113.94	10200	2.9				
12	194	105.83	10300	3.1				
14	176	95.91	10300	3.4				
15	158	86.11	10400	3.8				
4.7	505	186.89	6450	0.90	R	57	71M2-6	25
5.1	465	172.17	7030	0.95	RF	57	71M2-6	29



技术参数

Technical Data

P ₁ = 0.25 kW								
N _A rpm	M ₂ Nm	i	Fr ₂ MAX[N]	f _s	Type	Gear unit	Motor size	 Kg
6.0	400	147.92	7300	1.10				
6.8	350	128.77	7480	1.30	R	57	71M2-6	25
7.3	325	120.63	7550	1.35	RF	57	71M2-6	29
8.3	290	106.58	7660	1.55				
8.9	270	98.99	7710	1.70				
7.0	345	186.89	7500	1.30				
7.5	315	172.17	7590	1.40				
8.8	270	147.92	7700	1.65				
10	235	128.77	7780	1.90				
11	220	120.63	7810	2.0	R	57	71M1-4	24
12	196	106.58	7860	2.3	RF	57	71M1-4	27
13	182	98.99	7880	2.5				
14	165	89.71	7910	2.7				
16	148	80.55	7930	3.0				
19	127	69.23	7960	3.5				
7.4	325	176.88	5280	0.90				
8.0	300	162.94	5420	1.00				
9.3	255	139.99	5630	1.15				
11	225	121.87	5770	1.35				
11	210	114.17	5820	1.45				
13	185	100.86	5900	1.60				
14	172	93.68	5940	1.75	R	47	71M1-4	15
15	156	84.90	5980	1.90	RF	47	71M1-4	16
17	140	76.23	6020	2.1				
19	126	68.54	6050	2.4				
20	118	64.21	6070	2.5				
23	104	56.73	6090	2.9				
25	97	52.69	6100	3.1				
27	88	47.75	6080	3.4				
9.6	250	134.82	2630	0.80				
11	225	123.66	4560	0.90				
12	193	105.28	5030	1.05				
14	167	90.77	5320	1.20				
15	155	84.61	5420	1.30				
18	136	73.96	5590	1.45				
19	127	69.33	5650	1.55	R	37	71M1-4	15
21	112	61.18	5750	1.80	RF	37	71M1-4	16
23	102	55.76	5800	1.95				
27	88	48.08	5870	2.3				
29	82	44.81	5760	2.4				
33	72	39.17	5540	2.8				
35	67	36.72	5430	3.0				
40	60	32.40	5230	3.4				



技术参数

Technical Data

P ₁ = 0.25 kW								
NA rpm	M ₂ Nm	i	Fr ₂ MAX[N]	f _s	Type	Gear unit	Motor size	 Kg
15	156	84.78	4100	0.85				
18	136	74.11	4210	0.95				
19	128	69.47	4250	1.00				
21	113	61.30	4190	1.15				
23	103	55.87	4090	1.25				
27	89	48.17	3940	1.45	R	27	71M1-4	9.0
29	83	44.90	3870	1.60	RF	27	71M1-4	8.9
33	72	39.25	3730	1.80				
35	68	36.79	3670	1.90				
40	60	32.47	3540	2.2				
45	53	28.78	3420	2.5				
53	45	24.47	3270	2.9				
46	52	28.37	3410	2.5				
50	48	26.09	3330	2.7				
58	41	22.32	3180	3.2				
67	36	19.35	3050	3.7				
72	33	18.08	2990	3.9				
83	29	15.63	2860	4.5				
98	24	13.28	2730	5.3				
110	22	11.86	2630	5.9				
128	19	10.13	2510	6.6	R	27	71M1-4	8.7
138	17	9.41	2440	7.1	RF	27	71M1-4	8.6
159	15	8.16	2330	7.7				
170	14	7.63	2290	8.0				
197	12	6.59	2180	8.8				
232	10	5.60	2080	9.6				
260	9.2	5.00	2000	10				
304	7.8	4.27	1910	11				
325	7.3	4.00	1870	12				
386	6.2	3.37	1770	13				
23	105	57.35	156	0.80				
24	99	53.76	785	0.85				
27	87	47.44	1630	1.00				
29	81	44.18	2000	1.05	R	17	71M1-4	8.3
34	71	38.61	2200	1.20	RF	17	71M1-4	8.2
36	67	36.20	2180	1.30				
41	59	31.94	2130	1.45				
46	52	28.32	2070	1.65				
54	44	24.07	2000	1.90				
52	46	25.23	2020	1.85				
56	43	23.15	1980	2.0				
66	36	19.71	1910	2.4	R	17	71M1-4	8.0
77	31	16.99	1840	2.7	RF	17	71M1-4	7.9
82	29	15.84	1810	2.9				
94	25	13.84	1750	3.4				



技术参数

Technical Data

P₁ = 0.25 kW

NA rpm	M ₂ Nm	i	Fr ₂ MAX[N]	f _s	Type	Gear unit	Motor size	 Kg
100	24	12.98	1720	3.6	R	17	71M1-4	8.0
114	21	11.45	1660	3.9	RF	17	71M1-4	7.9
145	17	6.07	4890	2.6				
170	14	5.18	4650	5.4	RX	67	71M2-6	19
194	12	4.53	4450	6.7	RXF	67	71M2-6	23
205	12	4.30	4380	6.8				
214	11	6.07	4310	3.9				
251	9.5	5.18	4100	7.9				
287	8.3	4.53	3920	9.9				
302	7.9	4.30	3860	10				
345	6.9	3.77	3700	13	RX	67	71M1-4	17
406	5.9	3.20	3500	17	RXF	67	71M1-4	21
450	5.3	2.89	3390	20				
511	4.7	2.54	3250	25				
542	4.4	2.40	3190	28				
636	3.8	2.04	3020	35				
160	15	5.50	3840	2.6				
174	14	5.07	3740	2.6	RX	57	71M2-6	16
202	12	4.35	3560	5.8	RXF	57	71M2-6	18
232	10	3.79	3410	6.7				
236	10	5.50	3390	3.9				
257	9.3	5.07	3300	3.9				
299	8.0	4.35	3150	8.5				
343	7.0	3.79	3010	9.9				
366	6.5	3.55	2950	11				
414	5.8	3.14	2830	11	RX	57	71M1-4	14
446	5.3	2.91	2760	13	RXF	57	71M1-4	16
492	4.8	2.64	2680	14				
548	4.4	2.37	2580	16				
637	3.7	2.04	2460	19				
677	3.5	1.92	2410	20				
787	3.0	1.65	2300	23				

P₁ = 0.37 kW

0.19	15900	7307	37500	0.80				
0.21	14100	6447	60400	0.90				
0.25	12100	5568	64300	1.05				
0.28	10900	4926	66400	1.20	R	147 R77	71M2-4	420
0.32	9480	4325	68500	1.35	RF	147 R77	71M2-4	430
0.37	8310	3754	70000	1.55				
0.42	7240	3302	71100	1.80				
0.48	6320	2898	71900	2.1				



技术参数

Technical Data

P ₁ = 0.37 kW								
NA rpm	M ₂ Nm	i	Fr ₂ MAX[N]	f _s	Type	Gear unit	Motor size	 Kg
0.31	9740	4464	39400	0.80	R	137 R77	71M2-4	290
0.35	8570	3928	51500	0.95	RF	137 R77	71M2-4	315
0.34	9080	4018	49200	0.90				
0.39	7940	3514	53500	1.00				
0.41	7540	3338	54300	1.05	R	137 R77	71M2-4	280
0.47	6620	2929	56000	1.20	RF	137 R77	71M2-4	305
0.56	5600	2484	57600	1.45				
0.62	5030	2242	58400	1.60				
0.52	6000	2658	57000	1.35				
0.57	5440	2412	57800	1.45				
0.67	4680	2073	58800	1.70				
0.75	4060	1839	59400	1.95	R	137 R77	71M2-4	290
0.99	3130	1397	60200	2.6	RF	137 R77	71M2-4	310
1.1	2720	1226	60500	2.9				
1.3	2440	1090	60700	3.3				
1.4	2130	951	60900	3.8				
0.67	4660	2067	27300	0.90				
0.82	3790	1693	31900	1.15				
0.89	3420	1550	33500	1.25	R	107 R77	71M2-4	195
0.98	3110	1407	34600	1.40	RF	107 R77	71M2-4	205
1.1	2670	1209	35900	1.60				
1.3	2330	1055	36400	1.85				
0.69	4450	1987	28600	0.95				
0.76	4030	1827	30800	1.05				
0.86	3490	1599	33200	1.25	R	107 R77	71M2-4	200
0.99	3090	1400	34600	1.40	RF	107 R77	71M2-4	210
1.1	2670	1226	35900	1.60				
1.5	2070	939	36700	2.1				
1.7	1790	822	37000	2.4				
1.1	2760	1207	22500	1.10	R	97 R57	71M2-4	130
1.3	2470	1084	24300	1.20	RF	97 R57	71M2-4	145
0.99	3180	1396	10800	0.95				
1.1	2780	1228	22500	1.10				
1.3	2480	1069	24200	1.20				
1.5	2160	938	25700	1.40				
1.7	1860	824	26900	1.60	R	97 R57	71M2-4	130
1.9	1670	737	27400	1.80	RF	97 R57	71M2-4	145
2.2	1430	632	27700	2.1				
3.2	980	431	28200	3.1				
3.6	860	379	28300	3.5				
4.1	765	336	28400	3.9				
1.7	1810	802	13800	0.85	R	87 R57	71M2-4	87
1.8	1700	754	15800	0.90	RF	87 R57	71M2-4	94



技术参数

Technical Data

P ₁ = 0.37 kW								
NA rpm	M ₂ Nm	i	Fr ₂ MAX[N]	f _s	Type	Gear unit	Motor size	 Kg
2.1	1450	649	17600	1.05	R	87 R57	71M2-4	87
					RF	87 R57	71M2-4	94
1.8	1780	776	15100	0.85	R RF	87 R57 87 R57	71M2-4 71M2-4	87 95
2.0	1570	685	16800	1.00				
2.3	1340	599	18300	1.15				
2.6	1170	525	19100	1.30				
3.0	1030	456	19700	1.50				
5.2	595	268	20000	2.6				
5.9	525	236	20000	2.9				
2.6	1260	538	18700	1.25	R RF	87 R57 87 R57	71M2-4 71M2-4	86 93
2.9	1100	472	19400	1.40				
3.5	930	400	20000	1.65				
3.8	830	361	20000	1.85				
3.7	860	373	9520	0.95	R RF	77 R37 77 R37	71M2-4 71M2-4	48 53
4.2	755	327	10500	1.10				
4.8	670	289	11100	1.20				
5.3	600	260	11600	1.35				
6.2	510	224	12000	1.60				
7.0	445	197	12300	1.85				
8.2	390	169	12500	2.1				
9.3	340	149	12700	2.4				
4.7	665	294	4670	0.90	R RF	67 R37 67 R37	71M2-4 71M2-4	42 45
5.3	600	261	7550	1.00				
5.9	540	234	8220	1.10				
6.9	460	200	8930	1.30				
2.7	1330	255.71	27900	2.3	R RF	97 97	90S-8 90S-8	115 130
2.8	1250	241.25	28000	2.4				
3.1	1120	216.28	28100	2.7				
3.6	970	186.30	28300	3.1				
3.1	1140	289.74	28100	2.6	R RF	97 97	80M1-6 80M1-6	105 125
3.5	1000	255.71	28200	3.0				
3.7	950	241.25	28300	3.2				
4.2	850	216.28	28400	3.5				
3.1	1130	216.54	19300	1.40	R RF	87 87	90S-8 90S-8	73 80
3.3	1070	205.71	19600	1.45				
3.7	940	181.77	20000	1.65				
3.6	970	246.54	20000	1.60	R RF	87 87	80M1-6 80M1-6	66 73
4.2	850	216.54	20000	1.80				
4.4	810	205.71	20000	1.90				
5.0	715	181.77	20000	2.2				
5.8	610	155.34	20000	2.5				
6.3	560	142.41	20000	2.8				



技术参数

Technical Data

P ₁ = 0.37 kW								
NA rpm	M ₂ Nm	i	Fr ₂ MAX[N]	f _s	Type	Gear unit	Motor size	 Kg
4.7	755	145.67	10500	1.10	R	77	90S-8	47
4.9	720	138.39	10800	1.15	RF	77	90S-8	53
5.6	630	121.42	11400	1.30				
5.4	655	166.59	11200	1.25	R	77	80M1-6	40
6.2	570	145.67	11700	1.45	RF	77	80M1-6	46
6.5	545	138.39	11900	1.50				
7.1	500	195.24	12100	1.65				
8.3	425	166.59	12400	1.90				
9.5	375	145.67	12600	2.2	R	77	71M2-4	38
10	355	138.39	12600	2.3	RF	77	71M2-4	44
11	310	121.42	12800	2.6				
13	265	102.99	12900	3.1				
15	240	92.97	12900	3.5				
5.7	620	158.14	7300	0.95	R	67	80M1-6	34
6.5	540	137.67	8210	1.10	RF	67	80M1-6	37
7.0	505	128.97	8530	1.20				
7.9	445	113.94	9010	1.35				
6.9	510	199.81	8480	1.15				
7.5	470	184.07	8820	1.25				
8.7	405	158.14	9310	1.50				
10	355	137.67	9620	1.70				
11	330	128.97	9740	1.80				
12	290	113.94	9920	2.1	R	67	71M2-4	32
13	270	105.83	10000	2.2	RF	67	71M2-4	35
14	245	95.91	10100	2.4				
16	220	86.11	10200	2.7				
19	190	74.17	10300	3.2				
20	179	69.75	10300	3.4				
23	157	61.26	10400	3.8				
24	146	56.89	10400	4.1				
7.0	505	128.77	6510	0.90	R	57	80M1-6	27
7.5	475	120.63	7000	0.95	RF	57	80M1-6	31
8.4	420	106.58	7240	1.10				
9.1	390	98.99	7350	1.15				
7.4	480	186.89	6980	0.95				
8.0	440	172.17	7140	1.00				
9.3	380	147.92	7390	1.20				
11	330	128.77	7550	1.35	R	57	71M2-4	25
11	310	120.63	7610	1.45	RF	57	71M2-4	29
13	275	106.58	7700	1.65				
14	255	98.99	7750	1.80				
15	230	89.71	7800	1.95				
17	205	80.55	7840	2.2				



技术参数

Technical Data

P ₁ = 0.37 kW								
NA rpm	M ₂ Nm	i	Fr ₂ MAX[N]	f _s	Type	Gear unit	Motor size	 Kg
20	177	69.23	7890	2.5				
21	166	64.85	7910	2.7	R	57	71M2-4	25
24	147	57.29	7760	3.1	RF	57	71M2-4	29
26	136	53.22	7600	3.3				
29	124	48.23	7380	3.6				
9.9	360	139.99	3490	0.85				
11	310	121.87	5350	0.95				
12	290	114.17	5460	1.05				
14	260	100.86	5630	1.15				
15	240	93.68	5700	1.25				
16	215	84.90	5790	1.40				
18	195	76.23	5870	1.55	R	47	71M2-4	20
20	176	68.54	5930	1.70	RF	47	71M2-4	20
21	164	64.21	5960	1.80				
24	145	56.73	6010	2.1				
26	135	52.69	5990	2.2				
29	122	47.75	5820	2.5				
32	110	42.87	5650	2.7				
37	95	36.93	5410	3.2				
40	89	34.73	5310	3.4				
41	87	33.79	5270	2.8				
44	80	31.12	5150	2.8	R	47	71M2-4	20
52	69	26.74	4920	4.4	RF	47	71M2-4	20
59	60	23.28	4720	5.0				
63	56	21.81	4620	5.4				
15	230	90.77	4250	0.85	R	37	71M2-4	16
16	215	84.61	4720	0.90	RF	37	71M2-4	17
19	189	73.96	5070	1.05				
20	178	69.33	5210	1.15				
23	157	61.18	5410	1.30				
25	143	55.76	5530	1.40				
29	123	48.08	5590	1.60				
31	115	44.81	5480	1.75	R	37	71M2-4	16
35	100	39.17	5290	2.0	RF	37	71M2-4	17
38	94	36.72	5190	2.1				
43	83	32.40	5010	2.4				
48	74	28.73	4850	2.7				
57	63	24.42	4620	3.2				
49	73	28.32	4830	2.8				
53	67	26.03	4710	2.8	R	37	71M2-4	16
62	57	22.27	4500	3.5	RF	37	71M2-4	17
71	49	19.31	4320	4.1				
76	46	18.05	4230	4.3				



技术参数

Technical Data

P ₁ = 0.37 kW								
NA rpm	M ₂ Nm	i	Fr ₂ MAX[N]	f _s	Type	Gear unit	Motor size	 Kg
88	40	15.60	4050	5.0	R	37	71M2-4	16
104	34	13.25	3850	5.6	RF	37	71M2-4	17
117	30	11.83	3720	6.0				
23	157	61.30	3870	0.85				
25	143	55.87	3800	0.90				
29	123	48.17	3680	1.05				
31	115	44.90	3620	1.15	R	27	71M2-4	9.9
35	101	39.25	3510	1.30	RF	27	71M2-4	9.8
38	94	36.79	3460	1.40				
43	83	32.47	3350	1.55				
48	74	28.78	3250	1.75				
56	63	24.47	3110	2.1				
49	73	28.37	3240	1.80				
53	67	26.09	3170	1.95				
62	57	22.32	3040	2.3	R	27	71M2-4	9.6
71	50	19.35	2920	2.6	RF	27	71M2-4	9.6
76	46	18.08	2860	2.8				
88	40	15.63	2750	3.3				
104	34	13.28	2620	3.8				
36	99	38.61	770	0.85				
38	93	36.20	1260	0.90	R	17	71M2-4	9.2
43	82	31.94	1910	1.05	RF	17	71M2-4	9.1
49	73	28.32	1880	1.15				
57	62	24.07	1830	1.40				
55	65	25.23	1840	1.30				
60	59	23.15	1820	1.45				
70	51	19.71	1760	1.70				
81	44	16.99	1710	1.95				
87	41	15.84	1680	2.1				
100	35	13.84	1630	2.4				
106	33	12.98	1610	2.6				
121	29	11.45	1560	2.8	R	17	71M2-4	8.9
136	26	10.15	1520	3.0	RF	17	71M2-4	8.8
160	22	8.63	1460	3.3				
183	19	7.55	1370	2.9				
196	18	7.04	1350	3.1				
224	16	6.15	1300	3.4				
239	15	5.76	1280	3.6				
271	13	5.09	1240	3.9				
306	12	4.51	1200	4.2				
360	9.8	3.83	1150	4.6				
174	20	5.18	4570	3.7	RX	67	80M1-6	21
199	18	4.53	4380	4.6	RXF	67	80M1-6	25
209	17	4.30	4310	4.7				



技术参数

Technical Data

P₁ = 0.37 kW								
--------------------------------	--	--	--	--	--	--	--	--

N _A rpm	M ₂ Nm	i	Fr ₂ MAX[N]	f _s	Type	Gear unit	Motor size	Kg
239	15	3.77	4130	5.9	RX RXF	67 67	80M1-6 80M1-6	21 25
227	16	6.07	4200	2.8				
267	13	5.18	3990	5.6				
305	12	4.53	3820	7.1				
321	11	4.30	3760	7.3				
366	9.7	3.77	3610	9.0	RX	67	71M2-4	19
431	8.2	3.20	3420	12	RXF	67	71M2-4	23
478	7.4	2.89	3310	14				
543	6.5	2.54	3170	18				
575	6.1	2.40	3110	20				
675	5.2	2.04	2950	26				
207	17	4.35	3500	4.0	RX	57	80M1-6	18
238	15	3.79	3350	4.6	RXF	57	80M1-6	20
254	14	3.55	3280	5.0				
251	14	5.50	3300	2.8				
272	13	5.07	3210	2.8				
317	11	4.35	3060	6.1				
364	9.7	3.79	2930	7.1				
389	9.1	3.55	2870	7.6	RX	57	71M2-4	16
440	8.0	3.14	2760	8.1	RXF	57	71M2-4	18
474	7.5	2.91	2690	8.9				
523	6.8	2.64	2610	10				
582	6.1	2.37	2520	11				
676	5.2	2.04	2400	13				
719	4.9	1.92	2350	14				

P₁ = 0.55 kW								
--------------------------------	--	--	--	--	--	--	--	--

0.22	19800	6077	120000	0.90				
0.25	17600	5407	120000	1.00	R	167 R97	80M1-4	750
0.29	15000	4650	120000	1.20	RF	167 R97	80M1-4	760
0.33	13100	4129	120000	1.35				
0.28	16900	4926	22000	0.75				
0.31	14700	4325	53900	0.90	R	147 R77	80M1-4	425
0.36	12900	3754	62900	1.00	RF	147 R77	80M1-4	430
0.41	11200	3302	65900	1.15				
0.47	9830	2898	68000	1.30				
0.53	8890	2555	69300	1.45				
0.62	7700	2211	70600	1.70				
0.70	6790	1951	71500	1.90	R	147 R77	80M1-4	420
0.80	5810	1705	72400	2.2	RF	147 R77	80M1-4	430
0.89	5210	1536	72800	2.5				
1.0	4510	1329	73300	2.9				



技术参数

Technical Data

P ₁ = 0.55 kW								
Na rpm	M ₂ Nm	i	Fr ₂ MAX[N]	f _s	Type	Gear unit	Motor size	 Kg
1.2	3920	1166	73600	3.3	R	147 R77	80M1-4	420
					RF	147 R77	80M1-4	430
0.55	8650	2484	51200	0.90	R RF	137 R77	80M1-4	290
0.51	9250	2658	48400	0.85				
0.56	8400	2412	52300	0.95				
0.66	7220	2073	55000	1.10				
0.74	6320	1839	56500	1.25				
0.85	5420	1598	57900	1.50				
0.97	4840	1397	58600	1.65				
1.1	4220	1226	59300	1.90				
1.2	3780	1090	59700	2.1				
1.4	3300	951	60100	2.4				
1.6	2820	831	60500	2.8				
0.97	4830	1407	21900	0.90				
1.1	4150	1209	30200	1.05				
1.3	3620	1055	32700	1.20				
1.5	3170	919	34400	1.35				
1.7	2830	815	35500	1.50				
1.9	2470	717	36200	1.75				
2.2	2160	626	36600	2.0				
0.97	4810	1400	22800	0.90	R RF	107 R77	80M1-4	205
1.1	4180	1226	30100	1.05				
1.2	3740	1104	32200	1.15				
1.4	3220	939	34200	1.35				
1.7	2800	822	35600	1.55				
1.7	2870	824	21800	1.05	R RF	97 R57	80M1-4	130
1.8	2570	737	23700	1.15				
2.1	2200	632	25500	1.35				
2.4	1920	560	26700	1.55				
2.8	1670	484	27400	1.80				
3.1	1510	431	27600	2.0				
3.6	1320	379	27900	2.3				
4.0	1180	336	28000	2.6				
4.6	1030	296	28200	2.9				
5.5	860	249	28300	3.5				
2.6	1820	525	13600	0.85				
3.0	1580	456	16700	1.00				
3.4	1370	398	18100	1.15				
3.9	1210	352	18900	1.30				
4.5	1040	305	19700	1.50				
2.9	1690	472	15900	0.90	R RF	87 R57	80M1-4	88
3.4	1420	400	17800	1.10				
3.8	1280	361	18600	1.20				



技术参数

Technical Data

P ₁ = 0.55 kW								
NA rpm	M ₂ Nm	i	Fr ₂ MAX[N]	f _s	Type	Gear unit	Motor size	 Kg
4.9	990	276	4510	0.85				
5.8	840	236	9730	1.00	R	77 R37	80M1-4	49
6.2	785	221	10200	1.05	RF	77 R37	80M1-4	54
7.3	660	186	11200	1.25				
2.7	1980	255.71	26500	1.50	R	97	80M1-4	115
2.8	1860	241.25	26900	1.60	RF	97	80M1-4	130
3.1	1670	216.28	27400	1.80				
3.1	1690	289.74	27400	1.75				
3.5	1490	255.71	27700	2.0	R	97	80M2-6	110
3.7	1410	241.25	27800	2.1	RF	97	80M2-6	125
4.2	1260	216.28	28000	2.4				
4.7	1120	289.74	28100	2.7				
5.3	990	255.71	28200	3.0	R	97	80M1-4	105
5.6	930	241.25	28300	3.2	RF	97	80M1-4	125
6.3	840	216.28	28400	3.6				
3.6	1440	246.54	17700	1.10				
4.2	1260	216.54	18700	1.25	R	87	80M1-4	68
4.4	1200	205.71	19000	1.30	RF	87	80M1-4	75
5.0	1060	181.77	19600	1.45				
5.8	910	155.34	20000	1.70				
5.5	950	246.54	20000	1.65				
6.3	840	216.54	20000	1.85				
6.6	795	205.71	20000	1.95				
7.5	700	181.77	20000	2.2	R	87	80M1-4	66
8.8	600	155.34	20000	2.6	RF	87	80M1-4	73
9.6	550	142.41	20000	2.8				
11	485	124.97	20000	3.2				
11	455	118.43	20000	3.4				
13	400	103.65	20000	3.9				
8.2	645	166.59	11300	1.25				
9.3	565	145.67	11800	1.45				
9.8	535	138.39	11900	1.55				
11	470	121.42	12200	1.75	R	77	80M1-4	40
13	400	102.99	12500	2.1	RF	77	80M1-4	46
15	360	92.97	12600	2.3				
17	315	81.80	12800	2.6				
18	300	77.24	12800	2.8				
21	255	65.77	12900	3.2				
8.6	610	158.14	7430	1.00				
9.9	530	137.67	8290	1.15	R	67	80M1-4	34
11	500	128.97	8600	1.20	RF	67	80M1-4	37
12	440	113.94	9060	1.35				
13	410	105.83	9280	1.45				



技术参数

Technical Data

P ₁ = 0.55 kW								
NA rpm	M ₂ Nm	i	Fr ₂ MAX[N]	f _s	Type	Gear unit	Motor size	 Kg
14	370	95.91	9520	1.60				
16	335	86.11	9730	1.80				
18	285	74.17	9940	2.1	R	67	80M1-4	34
20	270	69.75	10000	2.2	RF	67	80M1-4	37
22	235	61.26	10100	2.5				
24	220	56.89	10200	2.7				
<hr/>								
11	465	120.63	7030	0.95				
13	410	106.58	7260	1.10				
14	380	98.99	7370	1.20				
15	345	89.71	7490	1.30				
17	310	80.55	7600	1.45				
20	265	69.23	7710	1.70	R	57	80M1-4	27
21	250	64.85	7750	1.80	RF	57	80M1-4	31
24	220	57.29	7530	2.0				
26	205	53.22	7390	2.2				
28	186	48.23	7190	2.4				
31	167	43.30	6980	2.7				
36	144	37.30	6700	3.1				
39	136	35.07	6580	3.3				
<hr/>								
52	102	26.31	6060	4.4	R	57	80M1-4	27
54	97	24.99	5970	4.7				
62	85	21.93	5740	5.3	RF	57	80M1-4	30
73	72	18.60	5460	6.3				
<hr/>								
15	360	93.68	3280	0.85				
16	330	84.90	5230	0.90				
18	295	76.23	5450	1.00				
20	265	68.54	5600	1.15				
21	250	64.21	5670	1.20				
24	220	56.73	5790	1.35	R	47	80M1-4	22
26	205	52.69	5770	1.45	RF	47	80M1-4	22
28	184	47.75	5630	1.65				
32	166	42.87	5470	1.80				
37	143	36.93	5260	2.1				
39	134	34.73	5180	2.2				
46	115	29.88	4970	2.6				
<hr/>								
51	103	26.74	4820	2.9	R	47	80M1-4	22
58	90	23.28	4630	3.3	RF	47	80M1-4	22
62	84	21.81	4550	3.6				
<hr/>								
22	235	61.18	3910	0.85				
24	215	55.76	4740	0.95				
28	186	48.08	5120	1.10	R	37	80M1-4	18
30	173	44.81	5230	1.15	RF	37	80M1-4	19
35	151	39.17	5070	1.30				
37	142	36.72	4990	1.40				



技术参数

Technical Data

P ₁ = 0.55 kW								
NA rpm	M ₂ Nm	i	Fr ₂ MAX[N]	f _s	Type	Gear unit	Motor size	 Kg
42	125	32.40	4840	1.60	R	37	80M1-4	18
47	111	28.73	4700	1.80	RF	37	80M1-4	19
56	94	24.42	4500	2.1				
61	86	22.27	4390	2.3				
70	75	19.31	4220	2.7				
75	70	18.05	4140	2.9	R	37	80M1-4	18
87	60	15.60	3970	3.3	RF	37	80M1-4	19
103	51	13.25	3790	3.7				
115	46	11.83	3670	4.0				
35	152	39.25	3280	0.85				
37	142	36.79	3240	0.90	R	27	80M1-4	12
42	125	32.47	3160	1.05	RF	27	80M1-4	12
47	111	28.78	3080	1.15				
56	95	24.47	2970	1.40				
61	86	22.32	2910	1.50				
70	75	19.35	2810	1.75				
75	70	18.08	2760	1.85				
87	60	15.63	2660	2.2				
102	51	13.28	2550	2.5				
115	46	11.86	2470	2.8				
134	39	10.13	2370	3.1				
145	36	9.41	2290	3.4	R	27	80M1-4	12
167	32	8.16	2200	3.7	RF	27	80M1-4	12
178	29	7.63	2160	3.8				
206	26	6.59	2070	4.2				
243	22	5.60	1980	4.6				
272	19	5.00	1910	4.9				
318	17	4.27	1830	5.3				
340	15	4.00	1790	5.5				
404	13	3.37	1700	6.1				
50	105	53.76	235	0.80	R	17	71M2-2	9.2
57	92	47.44	1280	0.90	RF	17	71M2-2	9.1
61	86	44.18	1610	1.00				
70	75	38.61	1590	1.15				
69	76	19.71	1590	1.10				
80	66	16.99	1560	1.30				
86	61	15.84	1550	1.40				
98	54	13.84	1510	1.60				
105	50	12.98	1500	1.70	R	17	80M1-4	11
119	44	11.45	1460	1.85	RF	17	80M1-4	11
134	39	10.15	1430	1.95				
158	33	8.63	1380	2.2				
180	29	7.55	1290	1.90				
193	27	7.04	1270	2.0				



技术参数

Technical Data

P ₁ = 0.55 kW								
NA rpm	M ₂ Nm	i	Fr ₂ MAX[N]	f _s	Type	Gear unit	Motor size	 Kg
221	24	6.15	1240	2.3				
236	22	5.76	1220	2.4	R	17	80M1-4	11
267	20	5.09	1190	2.6	RF	17	80M1-4	11
302	17	4.51	1150	2.8				
355	15	3.83	1110	3.0				
313	17	8.63	1170	4.3				
358	15	7.55	1100	3.8	R	17	71M2-2	8.9
384	14	7.04	1080	4.0	RF	17	71M2-2	8.8
439	12	6.15	1050	4.5				
174	30	5.18	4510	2.5				
199	26	4.53	4320	3.1	RX	67	80M1-4	22
209	25	4.30	4260	3.2	RXF	67	80M1-4	26
239	22	3.77	4090	4.0				
263	20	5.18	3970	3.8				
300	18	4.53	3800	4.7				
316	17	4.30	3740	4.8				
360	15	3.77	3590	6.0				
425	12	3.20	3410	8.1				
471	11	2.89	3300	9.5	RX	67	80M1-4	21
535	9.8	2.54	3170	12	RXF	67	80M1-4	25
567	9.3	2.40	3110	13				
666	7.9	2.04	2950	17				
732	7.2	1.86	2860	18				
845	6.2	1.61	2730	18				
207	25	4.35	3440	2.7				
238	22	3.79	3300	3.1	RX	57	80M2-6	19
254	21	3.55	3230	3.3	RXF	57	80M2-6	21
287	18	3.14	3110	3.6				
309	17	2.91	3040	3.9				
312	17	4.35	3040	4.1				
359	15	3.79	2910	4.7				
383	14	3.55	2850	5.0				
434	12	3.14	2740	5.4				
467	11	2.91	2680	6.0				
515	10	2.64	2600	6.8	RX	57	80M1-4	18
574	9.2	2.37	2510	7.5	RXF	57	80M1-4	20
666	7.9	2.04	2390	8.7				
708	7.4	1.92	2350	9.3				
823	6.4	1.65	2230	11				
921	5.7	1.48	2150	12				
1045	5.0	1.30	2070	13				



技术参数

Technical Data

P ₁ = 0.75 kW								
NA rpm	M ₂ Nm	i	Fr ₂ MAX[N]	f _s	Type	Gear unit	Motor size	 Kg
0.30	20700	4650	120000	0.85	R	167 R97	80M2-4	750
0.33	18200	4129	120000	1.00	RF	167 R97	80M2-4	760
0.52	12100	2657	120000	1.50				
0.59	10500	2333	120000	1.70	R	167 R97	80M2-4	750
0.66	9300	2085	120000	1.95	RF	167 R97	80M2-4	760
0.96	6550	1438	120000	2.8				
0.42	15300	3302	46300	0.85	R	147 R77	80M2-4	425
0.48	13400	2898	61800	0.95	RF	147 R77	80M2-4	435
0.54	12100	2555	64400	1.10				
0.62	10500	2211	67100	1.25				
0.71	9230	1951	68800	1.40	R	147 R77	80M2-4	425
0.81	7940	1705	70400	1.65	RF	147 R77	80M2-4	435
0.90	7130	1536	71200	1.80				
1.0	6170	1329	72100	2.1				
1.2	5380	1166	72700	2.4				
0.74	8730	1863	50900	0.90				
0.87	7390	1586	54600	1.10	R	137 R77	80M2-4	285
0.99	6580	1391	56100	1.20	RF	137 R77	80M2-4	305
1.1	5920	1256	57100	1.35				
0.67	9810	2073	37900	0.80				
0.75	8610	1839	51400	0.95				
0.86	7410	1598	54600	1.10				
0.99	6590	1397	56100	1.20	R	137 R77	80M2-4	295
1.1	5750	1226	57400	1.40	RF	137 R77	80M2-4	315
1.3	5140	1090	58200	1.55				
1.4	4490	951	59000	1.80				
1.7	3860	831	59600	2.1				
1.9	3360	730	60100	2.4				
1.3	4940	1055	16400	0.85	R	107 R77	80M2-4	200
1.5	4310	919	29400	1.00	RF	107 R77	80M2-4	205
1.7	3840	815	31700	1.10				
1.5	4400	939	28900	1.00				
1.7	3830	822	31800	1.10	R	107 R77	80M2-4	205
3.7	1710	369	37100	2.5	RF	107 R77	80M2-4	210
4.3	1490	323	37200	2.9				
2.2	2990	632	20100	1.00				
2.5	2620	560	23400	1.15				
2.9	2270	484	25200	1.30				
3.2	2050	431	26200	1.45	R	97 R57	80M2-4	135
3.6	1800	379	27100	1.65	RF	97 R57	80M2-4	150
4.1	1600	336	27500	1.90				
4.7	1400	296	27800	2.1				
5.5	1170	249	28100	2.6				



技术参数

Technical Data

P ₁ = 0.75 kW								
NA rpm	M ₂ Nm	i	Fr ₂ MAX[N]	f _s	Type	Gear unit	Motor size	 Kg
3.5	1870	398	9720	0.85				
3.9	1650	352	16200	0.95	R	87 R57	80M2-4	90
4.5	1430	305	17700	1.10	RF	87 R57	80M2-4	98
5.2	1260	268	18700	1.25				
5.9	1110	236	19400	1.40				
3.8	1740	361	15500	0.90	R	87 R57	80M2-4	89
4.6	1440	300	17700	1.10	RF	87 R57	80M2-4	96
5.4	1220	256	18900	1.25				
2.8	2610	251.15	36000	1.65	R	107	80M2-4	180
3.0	2390	229.95	36300	1.80	RF	107	80M2-4	185
3.4	2110	203.16	36700	2.0				
3.2	2240	216.28	25300	1.35	R	97	100L1-8	125
3.7	1930	186.30	26600	1.55	RF	97	100L1-8	140
4.1	1760	170.02	27200	1.70				
3.5	2030	255.71	26200	1.45	R	97	90S-6	115
3.7	1920	241.25	26700	1.55	RF	97	90S-6	130
4.2	1720	216.28	27300	1.75				
4.8	1500	289.74	27600	2.0				
5.4	1330	255.71	27900	2.3				
5.7	1250	241.25	28000	2.4	R	97	80M2-4	110
6.4	1120	216.28	28100	2.7	RF	97	80M2-4	125
7.4	970	186.30	28300	3.1				
8.1	880	170.02	28300	3.4				
4.2	1720	216.54	15600	0.90	R	87	90S-6	73
4.4	1640	205.71	16300	0.95	RF	87	90S-6	80
5.0	1450	181.77	17600	1.05				
5.8	1240	155.34	18800	1.25	R	87	90S-6	73
6.3	1130	142.41	19300	1.35	RF	87	90S-6	80
5.6	1280	246.54	18600	1.20				
6.4	1120	216.54	19300	1.40				
6.7	1070	205.71	19600	1.45				
7.6	940	181.77	20000	1.65				
8.9	810	155.34	20000	1.90	R	87	80M2-4	68
9.7	740	142.41	20000	2.1	RF	87	80M2-4	75
11	650	124.97	20000	2.4				
12	615	118.43	20000	2.5				
13	540	103.65	20000	2.9				
15	485	93.38	20000	3.2				
8.3	860	166.59	9490	0.95	R	77	80M2-4	42
9.5	755	145.67	10500	1.10	RF	77	80M2-4	48
10	720	138.39	10800	1.15				



技术参数

Technical Data

P ₁ = 0.75 kW								
NA rpm	M ₂ Nm	i	Fr ₂ MAX[N]	f _s	Type	Gear unit	Motor size	 Kg
11	630	121.42	11400	1.30				
13	535	102.99	11900	1.55				
15	485	92.97	12200	1.70				
17	425	81.80	12400	1.95				
18	400	77.24	12500	2.1	R	77	80M2-4	42
21	340	65.77	12700	2.4	RF	77	80M2-4	48
24	300	57.68	12800	2.7				
27	270	52.07	12900	3.0				
30	240	45.81	12900	3.5				
32	225	43.26	13000	3.7				
11	670	128.97	4040	0.90				
12	590	113.94	7660	1.00				
13	550	105.83	8120	1.10				
14	500	95.91	8600	1.20				
16	445	86.11	9010	1.35	R	67	80M2-4	35
19	385	74.17	9430	1.55	RF	67	80M2-4	38
20	360	69.75	9570	1.65				
23	320	61.26	9800	1.90				
24	295	56.89	9910	2.0				
27	270	51.56	10000	2.2				
30	240	46.29	10100	2.5				
13	555	106.58	4610	0.80				
14	515	98.99	6200	0.90				
15	465	89.71	7040	0.95	R	57	80M2-4	28
17	420	80.55	7240	1.10	RF	57	80M2-4	32
20	360	69.23	7450	1.25				
21	335	64.85	7430	1.35				
24	295	57.29	7220	1.50				
26	275	53.22	7090	1.65				
29	250	48.23	6930	1.80				
32	225	43.30	6740	2.0	R	57	80M2-4	28
37	194	37.30	6490	2.3	RF	57	80M2-4	32
39	182	35.07	6380	2.5				
46	157	30.18	6130	2.9				
51	140	26.97	5940	3.2				
52	137	26.31	5900	3.3				
55	130	24.99	5820	3.5	R	57	80M2-4	28
63	114	21.93	5610	4.0	RF	57	80M2-4	31
74	97	18.60	5350	4.7				
20	355	68.54	3660	0.85				
21	335	64.21	4950	0.90	R	47	80M2-4	23
24	295	56.73	5450	1.00	RF	47	80M2-4	23
26	275	52.69	5480	1.10				
29	250	47.75	5370	1.20				



技术参数

Technical Data

P ₁ = 0.75 kW								
NA rpm	M ₂ Nm	i	Fr ₂ MAX[N]	f _s	Type	Gear unit	Motor size	 Kg
32	225	42.87	5240	1.35				
37	192	36.93	5060	1.55				
40	180	34.73	4980	1.65	R	47	80M2-4	23
46	155	29.88	4800	1.95	RF	47	80M2-4	23
52	139	26.70	4660	2.2				
58	122	23.59	4510	2.5				
52	139	26.74	4660	2.2				
59	121	23.28	4490	2.5				
63	113	21.81	4420	2.7	R	47	80M2-4	23
72	100	19.27	4270	3.0	RF	47	80M2-4	23
77	93	17.89	4180	3.1				
85	84	16.22	4070	3.3				
29	250	48.08	2330	0.80	R	37	80M2-4	19
31	235	44.81	4230	0.85	RF	37	80M2-4	20
35	205	39.17	4720	1.00				
38	191	36.72	4740	1.05				
43	168	32.40	4610	1.20	R	37	80M2-4	19
48	149	28.73	4490	1.35	RF	37	80M2-4	20
57	127	24.42	4320	1.60				
62	116	22.27	4230	1.75				
71	100	19.31	4080	2.0				
76	94	18.05	4010	2.1				
88	81	15.60	3850	2.5	R	37	80M2-4	19
104	69	13.25	3690	2.8	RF	37	80M2-4	20
117	61	11.83	3570	3.0				
137	53	10.11	3420	3.2				
146	49	9.47	3360	3.4				
48	149	28.78	2880	0.85	R	27	80M2-4	13
56	127	24.47	2800	1.00	RF	27	80M2-4	13
62	116	22.32	2750	1.10				
71	100	19.35	2670	1.30				
76	94	18.08	2630	1.40				
88	81	15.63	2550	1.60				
104	69	13.28	2450	1.90				
116	62	11.86	2380	2.1	R	27	80M2-4	13
136	53	10.13	2290	2.3	RF	27	80M2-4	13
147	49	9.41	2210	2.5				
169	42	8.16	2130	2.7				
181	40	7.63	2090	2.8				
209	34	6.59	2010	3.1				
246	29	5.60	1930	3.4				
276	26	5.00	1870	3.7				



技术参数

Technical Data

P ₁ = 0.75 kW								
NA rpm	M ₂ Nm	i	Fr ₂ MAX[N]	f _s	Type	Gear unit	Motor size	 Kg
70	102	19.71	465	0.85				
81	88	16.99	1390	0.95				
87	82	15.84	1380	1.05				
100	72	13.84	1370	1.20				
106	67	12.98	1360	1.25				
121	59	11.45	1350	1.35				
136	53	10.15	1320	1.45				
160	45	8.63	1290	1.60	R	17	80M2-4	12
183	39	7.55	1200	1.45	RF	17	80M2-4	12
196	37	7.04	1180	1.50				
224	32	6.15	1160	1.70				
239	30	5.76	1150	1.75				
271	26	5.09	1120	1.95				
306	23	4.51	1090	2.1				
360	20	3.83	1060	2.3				
236	30	11.45	1200	2.7				
266	27	10.15	1170	2.9				
313	23	8.63	1130	3.1				
358	20	7.55	1060	2.8				
384	19	7.04	1040	2.9	R	17	80M1-2	11
439	16	6.15	1010	3.3	RF	17	80M1-2	11
468	15	5.76	990	3.5				
531	14	5.09	960	3.8				
599	12	4.51	930	4.0				
704	10	3.83	890	4.4				
199	36	4.53	4260	2.3				
209	34	4.30	4200	2.3	RX	67	90S-6	27
239	30	3.77	4040	2.9	RXF	67	90S-6	31
281	26	3.20	3840	3.9				
267	27	5.18	3900	2.8				
305	24	4.53	3750	3.5				
321	22	4.30	3690	3.6				
366	20	3.77	3540	4.4				
431	17	3.20	3360	6.0				
478	15	2.89	3260	7.1	RX	67	80M2-4	22
543	13	2.54	3130	8.9	RXF	67	80M2-4	26
575	13	2.40	3070	9.8				
675	11	2.04	2920	13				
743	9.6	1.86	2830	13				
858	8.3	1.61	2700	14				
238	30	3.79	3240	2.3				
254	28	3.55	3180	2.4	RX	57	80M2-4	24
287	25	3.14	3060	2.6				
309	23	2.91	3000	2.9	RXF	57	80M2-4	26
341	21	2.64	2910	3.3				



技术参数

Technical Data

P₁ = 0.75 kW								
--------------------------------	--	--	--	--	--	--	--	--

N _A rpm	M ₂ Nm	i	Fr ₂ MAX[N]	f _s	Type	Gear unit	Motor size	Kg
317	23	4.35	2980	3.0				
364	20	3.79	2860	3.5				
389	18	3.55	2800	3.8				
440	16	3.14	2700	4.0				
474	15	2.91	2630	4.4				
523	14	2.64	2560	5.0	RX	57	80M2-4	19
582	12	2.37	2470	5.6	RXF	57	80M2-4	21
676	11	2.04	2360	6.5				
719	10	1.92	2310	6.9				
835	8.6	1.65	2210	8.0				
935	7.7	1.48	2130	8.8				
1060	6.8	1.30	2050	9.3				

P₁ = 1.1 kW								
-------------------------------	--	--	--	--	--	--	--	--

0.53	17900	2657	120000	1.00				
0.60	15600	2333	120000	1.15				
0.67	13800	2085	120000	1.30				
0.75	12300	1877	120000	1.45	R	167 R97	90S-4	760
0.84	11000	1670	120000	1.65	RF	167 R97	90S-4	760
0.97	9680	1438	120000	1.85				
1.1	8620	1279	120000	2.1				
1.2	7510	1123	120000	2.4				
0.63	15300	2211	46800	0.85				
0.72	13500	1951	61700	0.95				
0.82	11700	1705	65200	1.10				
0.91	10500	1536	67100	1.25				
1.1	9060	1329	69000	1.45	R	147 R77	90S-4	430
1.2	7920	1166	70400	1.65	RF	147 R77	90S-4	440
1.4	6960	1029	71400	1.85				
1.6	6030	889	72200	2.2				
1.8	5300	784	72700	2.5				
2.0	4680	695	73200	2.8				
1.0	9610	1391	41900	0.85				
1.1	8660	1256	51200	0.90				
1.3	7590	1105	54200	1.05	R	137 R77	90S-4	290
1.3	7160	1043	55100	1.10	RF	137 R77	90S-4	310
1.6	6070	888	56900	1.30				
1.0	9630	1397	41500	0.85				
1.1	8420	1226	52200	0.95				
1.3	7510	1090	54400	1.05				
1.5	6560	951	56100	1.20	R	137 R77	90S-4	300
1.7	5670	831	57500	1.40	RF	137 R77	90S-4	320
1.9	4950	730	58500	1.60				
2.2	4230	629	59300	1.90				



技术参数

Technical Data

P ₁ = 1.1 kW								
NA rpm	M ₂ Nm	i	Fr ₂ MAX[N]	f _s	Type	Gear unit	Motor size	 Kg
2.5	3830	560	59700	2.1	R	137 R77	90S-4	300
2.9	3300	490	60100	2.4	RF	137 R77	90S-4	320
1.9	4930	717	17300	0.85	R RF	107 R77	90S-4	205
2.3	4150	614	30200	1.05				
2.6	3670	544	32500	1.15				
2.8	3310	492	33900	1.30				
3.4	2810	417	35500	1.55				
3.8	2510	369	36200	1.70				
4.3	2200	323	36600	1.95				
4.9	1930	285	36800	2.2				
5.5	1700	253	37100	2.5				
3.2	2990	431	20300	1.00	R RF	97 R57	90S-4	140
3.7	2620	379	23400	1.15				
4.2	2330	336	24900	1.30				
4.7	2050	296	26200	1.45				
5.6	1710	249	27300	1.75				
6.0	1590	234	27500	1.90				
6.7	1430	209	27700	2.1				
5.2	1840	268	11700	0.85				
5.9	1630	236	16400	0.95				
6.7	1430	209	17700	1.10				
5.5	1780	256	15100	0.85	R RF	87 R57	90S-4	94
6.0	1610	232	16500	0.95				
7.2	1370	195	18100	1.15				
2.7	3940	251.15	31300	1.10	R RF	107	100L2-8	185
2.9	3610	229.95	32700	1.20				
3.3	3190	203.16	34300	1.35				
3.9	2700	172.34	35800	1.60				
3.6	2920	255.71	21500	1.05	R RF	97	90L-6	115
3.8	2750	241.25	22600	1.10				
4.2	2470	216.28	24200	1.20				
4.9	2130	186.30	25900	1.40				
5.5	1920	255.71	26700	1.55				
5.8	1810	241.25	27100	1.65	R RF	97	90S-4	115
6.5	1620	216.28	27500	1.85				
7.5	1400	186.30	27800	2.2				
8.2	1280	170.02	27900	2.4				
9.3	1130	150.78	28100	2.7				
11	950	126.75	28300	3.2				
12	870	116.48	28300	3.4				
6.5	1620	216.54	16400	0.95				
6.8	1540	205.71	17000	1.00				
7.7	1360	181.77	18100	1.15				



技术参数

Technical Data

P ₁ = 1.1 kW								
NA rpm	M ₂ Nm	i	Fr ₂ MAX[N]	f _s	Type	Gear unit	Motor size	 Kg
9.0	1170	155.34	19100	1.35				
9.8	1070	142.41	19600	1.45				
11	940	124.97	20000	1.65				
12	890	118.43	20000	1.75				
14	780	103.65	20000	2.0				
15	700	93.38	20000	2.2	R	87	90S-4	73
17	615	81.92	20000	2.5	RF	87	90S-4	80
19	545	72.57	20000	2.9				
22	480	63.68	20000	3.2				
23	455	60.35	20000	3.4				
27	395	52.82	20000	3.9				
12	910	121.42	8990	0.90	R	77	90S-4	47
14	775	102.99	10300	1.05	RF	77	90S-4	53
15	700	92.97	10900	1.20				
17	615	81.80	11500	1.35				
18	580	77.24	11700	1.40				
21	495	65.77	12100	1.65				
24	435	57.68	12400	1.90				
27	390	52.07	12500	2.1	R	77	90S-4	47
31	345	45.81	12700	2.4	RF	77	90S-4	53
32	325	43.26	12700	2.5				
38	275	36.83	12900	3.0				
42	250	33.47	12900	3.3				
16	645	86.11	6820	0.95				
19	555	74.17	8040	1.10				
20	525	69.75	8370	1.15				
23	460	61.26	8920	1.30				
25	425	56.89	9160	1.40				
27	385	51.56	9420	1.55	R	67	90S-4	40
30	345	46.29	9650	1.75	RF	67	90S-4	43
35	300	39.88	9890	1.95				
37	280	37.50	9970	2.0				
43	240	32.27	10100	2.2				
49	215	28.83	10200	2.4				
50	210	28.13	10200	2.6				
52	200	26.72	10100	2.7	R	67	90S-4	39
60	176	23.44	9730	3.2	RF	67	90S-4	42
70	149	19.89	9270	4.0				
20	520	69.23	5990	0.85	R	57	90S-4	34
22	485	64.85	6850	0.90	RF	57	90S-4	37
24	430	57.29	6700	1.05				
26	400	53.22	6610	1.15	R	57	90S-4	34
29	360	48.23	6490	1.25	RF	57	90S-4	37



技术参数

Technical Data

P ₁ = 1.1 kW								
NA rpm	M ₂ Nm	i	Fr ₂ MAX[N]	f _s	Type	Gear unit	Motor size	 Kg
32	325	43.30	6350	1.40				
38	280	37.30	6140	1.60	R	57	90S-4	34
40	265	35.07	6060	1.70	RF	57	90S-4	37
46	225	30.18	5850	2.0				
52	200	26.97	5690	2.2				
53	197	26.31	5650	2.3				
56	188	24.99	5580	2.4	R	57	90S-4	33
64	165	21.93	5400	2.7	RF	57	90S-4	36
75	140	18.60	5170	3.2				
83	126	16.79	5030	3.6				
29	360	47.75	3500	0.85				
33	320	42.87	4850	0.95				
38	275	36.93	4720	1.10	R	47	90S-4	28
40	260	34.73	4660	1.15	RF	47	90S-4	28
47	225	29.88	4520	1.35				
52	200	26.70	4410	1.50				
59	177	23.59	4290	1.70				
60	175	23.28	4270	1.70				
64	164	21.81	4210	1.85				
73	145	19.27	4080	2.0				
78	134	17.89	4010	2.2				
86	122	16.22	3910	2.3	R	47	90S-4	28
96	109	14.56	3800	2.4	RF	47	90S-4	28
112	94	12.54	3650	2.7				
119	89	11.79	3590	2.8				
138	76	10.15	3450	3.0				
154	68	9.07	3340	3.2				
43	245	32.40	2900	0.80	R	37	90S-4	24
49	215	28.73	3300	0.95	RF	37	90S-4	26
57	183	24.42	3720	1.10				
73	145	19.31	3840	1.40	R	37	90S-4	24
78	135	18.05	3790	1.50	RF	37	90S-4	25
90	117	15.60	3660	1.70				
106	99	13.25	3520	1.90				
118	89	11.83	3430	2.1				
139	76	10.11	3290	2.2				
148	71	9.47	3230	2.4	R	37	90S-4	24
176	60	7.97	3090	2.6	RF	37	90S-4	25
210	50	6.67	2920	2.9				
247	43	5.67	2790	3.3				
277	38	5.06	2700	3.6				
72	145	19.35	2430	0.90	R	27	90S-4	18
77	136	18.08	2410	0.95	RF	27	90S-4	18



技术参数

Technical Data

P ₁ = 1.1 kW								
NA rpm	M ₂ Nm	i	Fr ₂ MAX[N]	f _s	Type	Gear unit	Motor size	 Kg
90	117	15.63	2360	1.10				
105	100	13.28	2290	1.30				
118	89	11.86	2240	1.45				
138	76	10.13	2160	1.60				
172	61	8.16	2010	1.90				
184	57	7.63	1980	1.95	R	27	90S-4	18
212	50	6.59	1920	2.1	RF	27	90S-4	18
250	42	5.60	1840	2.4				
280	38	5.00	1790	2.5				
328	32	4.27	1720	2.7				
350	30	4.00	1690	2.8				
415	25	3.37	1610	3.1				
203	52	13.28	1980	2.5				
228	46	11.86	1920	2.8				
267	39	10.13	1840	3.1				
287	37	9.41	1780	3.3				
331	32	8.16	1720	3.7				
354	30	7.63	1690	3.8	R	27	80M2-2	13
410	26	6.59	1620	4.1	RF	27	80M2-2	13
482	22	5.60	1550	4.5				
540	20	5.00	1500	4.9				
632	17	4.27	1430	5.2				
675	16	4.00	1410	5.5				
801	13	3.37	1340	6.0				
137	77	19.71	1150	1.10				
159	66	16.99	1140	1.30				
170	62	15.84	1140	1.40				
195	54	13.84	1120	1.60				
208	51	12.98	1120	1.70				
236	45	11.45	1100	1.80				
266	40	10.15	1080	1.95				
313	34	8.63	1050	2.1	R	17	80M2-2	12
358	29	7.55	970	1.90	RF	17	80M2-2	12
384	27	7.04	960	2.0				
439	24	6.15	940	2.3				
468	22	5.76	930	2.4				
531	20	5.09	910	2.6				
599	18	4.51	880	2.7				
704	15	3.83	850	3.0				
249	42	5.63	5680	2.6	RX	77	90S-4	37
262	40	5.35	5590	2.6	RXF	77	90S-4	40
296	36	4.73	5380	3.5				
203	52	4.53	4130	1.60	RX	67	90L-6	29
214	49	4.30	4070	1.65	RXF	67	90L-6	33



技术参数

Technical Data

P ₁ = 1.1 kW								
NA rpm	M ₂ Nm	i	Fr ₂ MAX[N]	f _s	Type	Gear unit	Motor size	 Kg
244	43	3.77	3920	2.0	RX RXF	67 67	90L-6 90L-6	29 33
309	34	4.53	3660	2.4	RX RXF	67 67	90S-4 90S-4	27 31
326	32	4.30	3610	2.5				
371	28	3.77	3470	3.1				
438	24	3.20	3300	4.2				
485	22	2.89	3200	4.9				
551	19	2.54	3070	6.2				
583	18	2.40	3020	6.8				
685	15	2.04	2870	8.8				
754	14	1.86	2780	9.1				
870	12	1.61	2660	9.4				
1000	11	1.40	2550	9.9				
243	43	3.79	3120	1.60	RX RXF	57 57	90L-6 90L-6	26 28
259	41	3.55	3060	1.70				
293	36	3.14	2960	1.80				
316	33	2.91	2900	2.0				
348	30	2.64	2820	2.3				
369	28	3.79	2780	2.4	RX RXF	57 57	90S-4 90S-4	24 26
394	27	3.55	2730	2.6				
446	24	3.14	2630	2.8				
481	22	2.91	2570	3.1				
530	20	2.64	2500	3.5				
591	18	2.37	2420	3.9				
686	15	2.04	2310	4.5				
729	14	1.92	2270	4.8				
847	12	1.65	2160	5.6				
948	11	1.48	2090	6.1				
1075	9.8	1.30	2010	6.4				
P ₁ = 1.5 kW								
3.3	3920	426	73600	3.3	R RF	147 R87 147 R87	90L-4 90L-4	450 460
3.8	3380	368	73800	3.8				
0.83	15900	1705	37900	0.80	R RF	147 R77 147 R77	90L-4 90L-4	430 440
0.92	14300	1536	58600	0.90				
1.1	12400	1329	63900	1.05				
1.2	10800	1166	66500	1.20				
1.4	9530	1029	68400	1.35				
1.6	8250	889	70000	1.60				
1.8	7260	784	71100	1.80				
2.0	6420	695	71900	2.0				
2.3	5780	619	72400	2.3				
2.5	5200	558	72800	2.5				



技术参数

Technical Data

P ₁ = 1.5kW								
NA rpm	M ₂ Nm	i	Fr ₂ MAX[N]	f _s	Type	Gear unit	Motor size	 Kg
1.4	9770	1043	38800	0.80				
1.6	8290	888	52700	0.95	R	137 R77	90L-4	290
2.0	6500	699	56200	1.25	RF	137 R77	90L-4	315
2.3	5640	609	57600	1.40				
1.3	10200	1090	26100	0.80				
1.5	8940	951	49900	0.90				
1.7	7750	831	53900	1.05				
1.9	6770	730	55800	1.20				
2.2	5800	629	57300	1.40	R	137 R77	90L-4	300
2.5	5230	560	58100	1.55	RF	137 R77	90L-4	320
2.9	4530	490	59000	1.75				
3.3	3950	428	59600	2.0				
3.7	3560	381	59900	2.3				
4.4	3020	323	60300	2.7				
2.7	528	4900	18500	0.9	R	107 R77	90L-4	205
					RF	107 R77	90L-4	215
2.6	5030	544	10400	0.85				
2.9	4550	492	28100	0.95				
3.4	3850	417	31700	1.10	R	107 R77	90L-4	210
3.8	3440	369	33400	1.25	RF	107 R77	90L-4	220
4.4	3000	323	34900	1.45				
3.0	4470	469	28500	0.95	R	107 R77	90L-4	205
					RF	107 R77	90L-4	210
4.2	3170	336	11300	0.95				
4.8	2790	296	22400	1.10				
5.7	2330	249	24900	1.30	R	97 R57	90L-4	140
6.0	2180	234	25600	1.40	RF	97 R57	90L-4	155
6.8	1950	209	26600	1.55				
3.0	4710	229.95	26500	0.90				
3.5	4160	203.16	30200	1.05	R	107	100M-8	190
4.1	3530	172.34	33100	1.20	RF	107	100M-8	195
4.4	3250	158.68	34100	1.30				
3.7	3910	251.15	31400	1.10				
4.0	3580	229.95	32900	1.20				
4.5	3160	203.16	34400	1.35	R	107	100L-6	180
5.3	2680	172.34	35900	1.60	RF	107	100L-6	185
5.8	2470	158.68	36200	1.75				
6.5	2210	141.83	36500	1.95				
5.5	2600	255.71	23500	1.15				
5.8	2450	241.25	24300	1.20				
6.5	2200	216.28	25600	1.35	R	97	90L-4	115
7.6	1890	186.30	26800	1.60	RF	97	90L-4	130
8.3	1730	170.02	27300	1.75				



技术参数

Technical Data

P ₁ = 1.5kW								
NA rpm	M ₂ Nm	i	Fr ₂ MAX[N]	f _s	Type	Gear unit	Motor size	 Kg
9.3	1530	150.78	27600	1.95				
11	1290	126.75	27900	2.3	R	97	90L-4	115
12	1180	116.48	28000	2.5	RF	97	90L-4	130
14	1050	103.44	28200	2.9				
15	940	92.48	28300	3.2				
7.8	1850	181.77	11400	0.85				
9.1	1580	155.34	16700	1.00				
9.9	1450	142.41	17600	1.05	R	87	90L-4	74
11	1270	124.97	18600	1.20	RF	87	90L-4	81
12	1200	118.43	19000	1.30				
14	1050	103.65	19600	1.45				
15	950	93.38	20000	1.65				
17	830	81.92	20000	1.85				
19	735	72.57	20000	2.1				
22	645	63.68	20000	2.4	R	87	90L-4	74
23	615	60.35	20000	2.5	RF	87	90L-4	81
27	535	52.82	20000	2.9				
30	485	47.58	20000	3.2				
34	425	41.74	20000	3.7				
38	375	36.84	19600	4.1				
15	940	92.97	8500	0.85	R	77	90L-4	48
17	830	81.80	9820	1.00	RF	77	90L-4	54
18	785	77.24	10200	1.05				
21	670	65.77	11100	1.25				
24	585	57.68	11600	1.40				
27	530	52.07	11900	1.55				
31	465	45.81	12200	1.75				
33	440	43.26	12300	1.85	R	77	90L-4	48
38	375	36.83	12600	2.2	RF	77	90L-4	54
42	340	33.47	12700	2.4				
49	295	29.00	12500	2.8				
56	255	25.23	12000	3.0				
60	240	23.37	11800	3.5	R	77	90L-4	47
66	220	21.43	11500	3.8	RF	77	90L-4	53
75	191	18.80	11000	4.1				
23	620	61.26	7280	0.95				
25	580	56.89	7810	1.05				
27	525	51.56	8370	1.15				
30	470	46.29	8830	1.30	R	67	90L-4	42
35	405	39.88	9300	1.45	RF	67	90L-4	45
38	380	37.50	9460	1.50				
44	330	32.27	9750	1.65				
49	295	28.83	9920	1.80				



技术参数

Technical Data

P ₁ = 1.5kW								
NA rpm	M ₂ Nm	i	Fr ₂ MAX[N]	f _s	Type	Gear unit	Motor size	 Kg
50	285	28.13	9950	1.90				
53	270	26.72	9850	2.0				
60	240	23.44	9500	2.4	R	67	90L-4	41
71	200	19.89	9070	3.0	RF	67	90L-4	44
79	182	17.95	8810	3.2				
<hr/>								
27	540	53.22	5140	0.85	R	57	90L-4	36
29	c490	48.23	6010	0.90	RF	57	90L-4	39
33	440	43.30	5920	1.00				
<hr/>								
38	380	37.30	5770	1.20				
40	355	35.07	5710	1.25	R	57	90L-4	36
47	305	30.18	5540	1.45	RF	57	90L-4	39
52	275	26.97	5420	1.65				
<hr/>								
54	265	26.31	5390	1.70				
56	255	24.99	5330	1.75				
64	225	21.93	5170	2.0				
76	189	18.60	4980	2.4	R	57	90L-4	35
84	171	16.79	4850	2.6	RF	57	90L-4	38
95	150	14.77	4700	2.9				
101	142	13.95	4630	3.0				
119	121	11.88	4440	3.4				
<hr/>								
38	375	36.93	2380	0.80				
41	355	34.73	3840	0.85	R	47	90L-4	30
47	305	29.88	4220	1.00	RF	47	90L-4	30
53	270	26.70	4140	1.10				
60	240	23.59	4050	1.25				
<hr/>								
61	235	23.28	4040	1.25				
65	220	21.81	3990	1.35				
73	196	19.27	3890	1.50				
79	182	17.89	3830	1.60				
87	165	16.22	3740	1.65				
97	148	14.56	3650	1.80				
112	127	12.54	3520	1.95				
120	120	11.79	3470	2.1				
139	103	10.15	3340	2.2	R	47	90L-4	30
155	92	9.07	3240	2.4	RF	47	90L-4	30
176	81	8.01	3140	2.5				
182	79	7.76	3060	2.1				
203	71	6.96	2980	2.3				
235	61	6.00	2860	2.6				
250	57	5.64	2810	2.7				
291	49	4.85	2700	3.0				
325	44	4.34	2610	3.3				
368	39	3.83	2520	3.7				



技术参数

Technical Data

P ₁ = 1.5kW								
NA rpm	M ₂ Nm	i	Fr ₂ MAX[N]	f _s	Type	Gear unit	Motor size	 Kg
73	196	19.31	2660	1.00	R	37	90L-4	25
78	183	18.05	2840	1.10	RF	37	90L-4	27
90	159	15.60	3160	1.25				
106	135	13.25	3350	1.40				
119	120	11.83	3270	1.50				
140	103	10.11	3160	1.65				
149	96	9.47	3110	1.75				
177	81	7.97	2980	1.95	R	37	90L-4	25
211	68	6.67	2820	2.1	RF	37	90L-4	27
249	58	5.67	2710	2.5				
279	51	5.06	2630	2.6				
326	44	4.32	2520	2.9				
348	41	4.05	2470	3.0				
414	35	3.41	2360	3.2				
211	68	13.25	2850	2.8	R	37	90S-2	24
237	61	11.83	2770	3.0	RF	37	90S-2	25
277	52	10.11	2650	3.3				
296	48	9.47	2610	3.5				
351	41	7.97	2480	3.8				
90	159	15.63	1700	0.80				
106	135	13.28	2020	0.95				
119	121	11.86	2080	1.05				
139	103	10.13	2030	1.20				
173	83	8.16	1880	1.40				
185	78	7.63	1860	1.45	R	27	90L-4	19
214	67	6.59	1810	1.60	RF	27	90L-4	19
252	57	5.60	1750	1.75				
282	51	5.00	1710	1.85				
330	43	4.27	1650	2.0				
353	41	4.00	1630	2.1				
418	34	3.37	1560	2.3				
236	61	11.86	1820	2.1				
276	52	10.13	1760	2.4				
343	42	8.16	1640	2.8				
367	39	7.63	1610	2.9				
425	34	6.59	1550	3.2	R	27	90S-2	18
500	29	5.60	1490	3.5	RF	27	90S-2	18
560	26	5.00	1450	3.7				
656	22	4.27	1390	4.0				
700	21	4.00	1360	4.2				
831	17	3.37	1300	4.6				
250	57	5.63	5580	1.90	R	77	90L-4	38
264	54	5.35	5490	1.90	RF	77	90L-4	41
298	48	4.73	5300	2.6				



技术参数

Technical Data

P₁ = 1.5kW								
------------------------------	--	--	--	--	--	--	--	--

N _A rpm	M ₂ Nm	i	Fr ₂ MAX[N]	f _s	Type	Gear unit	Motor size	Kg
349	41	4.04	5050	3.5				
381	38	3.70	4920	4.1				
434	33	3.25	4720	5.5	R	77	90L-4	38
458	31	3.08	4650	6.2	RF	77	90L-4	41
523	27	2.70	4460	7.9				
581	25	2.43	4310	8.7				
<hr/>								
312	46	4.53	3570	1.80				
328	44	4.30	3520	1.85				
374	38	3.77	3390	2.3				
441	33	3.20	3230	3.1				
488	29	2.89	3140	3.6	RX	67	90L-4	29
555	26	2.54	3020	4.6	RXF	67	90L-4	33
588	24	2.40	2970	5.0				
690	21	2.04	2820	6.4				
759	19	1.86	2740	6.7				
876	16	1.61	2620	7.0				
1005	14	1.40	2510	7.3				
<hr/>								
372	39	3.79	2700	1.80				
397	36	3.55	2650	1.90				
450	32	3.14	2560	2.0				
484	30	2.91	2510	2.3				
534	27	2.64	2440	2.6				
595	24	2.37	2360	2.9	RX	57	90L-4	26
691	21	2.04	2260	3.3	RXF	57	90L-4	28
734	20	1.92	2220	3.5				
853	17	1.65	2120	4.1				
955	15	1.48	2050	4.5				
1080	13	1.30	1980	4.7				

P₁ = 2.2kW								
------------------------------	--	--	--	--	--	--	--	--

0.84	22600	1670	120000	0.80				
0.98	19700	1438	120000	0.90				
1.1	17500	1279	120000	1.05				
1.3	15300	1123	120000	1.15	R	167 R97	100L1-4	770
1.4	13600	999	120000	1.30	RF	167 R97	100L1-4	770
1.6	11800	861	120000	1.55				
1.9	10400	760	120000	1.75				
2.1	8730	656	120000	2.1				
<hr/>								
2.6	7200	533	71100	1.80				
3.1	6190	462	72100	2.1				
3.3	5820	426	72400	2.2	R	147 R87	100L1-4	460
3.8	5030	368	72900	2.6	RF	147 R87	100L1-4	465
4.3	4450	326	73300	2.9				



技术参数

Technical Data

P ₁ = 2.2kW								
NA rpm	M ₂ Nm	i	Fr ₂ MAX[N]	f _s	Type	Gear unit	Motor size	 Kg
1.2	16000	1166	36000	0.80				
1.4	14100	1029	60300	0.90				
1.6	12200	889	64200	1.05				
1.8	10800	784	66600	1.20	R	147 R77	100L1-4	435
2.0	9520	695	68500	1.35	RF	147 R77	100L1-4	445
2.3	8550	619	69700	1.50				
2.5	7690	558	70600	1.70				
2.9	6730	489	71600	1.95				
2.0	9620	699	41800	0.85	R	137 R77	100L1-4	295
2.3	8350	609	52500	0.95	RF	137 R77	100L1-4	320
1.9	10000	730	33300	0.80				
2.2	8610	629	51400	0.95				
2.5	7730	560	54000	1.05				
2.9	6720	490	55900	1.20				
3.3	5860	428	57200	1.35	R	137 R77	100L1-4	305
3.7	5260	381	58100	1.50	RF	137 R77	100L1-4	330
4.4	4460	323	59000	1.80				
4.8	4020	291	59500	2.0				
5.5	3510	255	59900	2.3				
6.3	3070	223	60300	2.6				
4.4	4450	323	28600	0.95				
4.9	3920	285	31400	1.10	R	107 R77	100L1-4	220
5.6	3470	253	33300	1.25	RF	107 R77	100L1-4	225
6.6	2940	214	35100	1.45				
4.4	4540	325	28100	0.95	R	107 R77	100L1-4	215
					RF	107 R77	100L1-4	220
6.8	2880	209	21800	1.05	R	97 R57	100L1-4	145
					RF	97 R57	100L1-4	165
3.1	6680	222.60	55900	1.20				
3.7	5660	188.45	57500	1.40				
4.0	5230	174.40	58100	1.55	R	137	Y132S-8	295
4.5	4690	156.31	58800	1.70	RF	137	Y132S-8	320
5.0	4240	141.12	59300	1.90				
5.5	3850	128.18	59600	2.1	R	137	Y132S-8	295
6.2	3410	113.72	60000	2.3	RF	137	Y132S-8	320
6.8	3100	103.20	60300	2.6				
4.6	4540	203.16	28100	0.95				
5.5	3850	172.34	31700	1.10	R	107	Y112M-6	190
5.9	3550	158.68	33000	1.20	RF	107	Y112M-6	195
6.6	3170	141.83	34400	1.35				
5.6	3740	251.15	32200	1.15	R	107	100L1-4	180
6.1	3430	229.95	33500	1.25	RF	107	100L1-4	185



技术参数

Technical Data

P ₁ = 2.2kW								
NA rpm	M ₂ Nm	i	Fr ₂ MAX[N]	f _s	Type	Gear unit	Motor size	 Kg
6.9	3030	203.16	34900	1.40	R	107	100L1-4	180
					RF	107	100L1-4	185
8.2	2570	172.34	36100	1.65	R RF	107	100L1-4	180
8.9	2360	158.68	36300	1.80				
9.9	2110	141.83	36600	2.0				
11	1900	127.68	36900	2.3				
12	1720	115.63	37000	2.5				
14	1530	102.53	37200	2.8				
15	1380	92.70	37300	3.1				
6.5	3220	216.28	7030	0.95	R	97	100L1-4	125
7.6	2780	186.30	22500	1.10	RF	97	100L1-4	140
8.3	2530	170.02	23900	1.20				
9.3	2250	150.78	25300	1.35	R RF	97	100L1-4	125
11	1890	126.75	26800	1.60				
12	1740	116.48	27300	1.75				
14	1540	103.44	27600	1.95				
15	1380	92.48	27800	2.2				
17	1240	83.15	28000	2.4				
20	1080	72.17	28200	2.8				
22	970	65.21	27700	3.1				
24	890	59.92	27000	3.4				
27	795	53.21	26100	3.8				
30	710	47.58	25300	4.2				
11	1860	124.97	10100	0.85	R RF	87	100L1-4	82
12	1760	118.43	15200	0.90				
14	1540	103.65	17000	1.00				
15	1390	93.38	17900	1.10				
17	1220	81.92	18900	1.25				
19	1080	72.57	19500	1.45	R RF	87	100L1-4	82
22	950	63.68	20000	1.65				
23	900	60.35	20000	1.70				
27	785	52.82	20000	1.95				
30	710	47.58	20000	2.2				
34	620	41.74	19900	2.5				
38	550	36.84	19200	2.8				
43	485	32.66	18500	3.2				
41	515	34.40	18800	2.9				
45	470	31.40	18300	3.3	R RF	87	100L1-4	81
51	415	27.84	17700	3.7				
60	350	23.40	16800	4.5				
66	320	21.51	16400	4.7				
21	980	65.77	5470	0.85				
24	860	57.68	9540	0.95	RF	77	100L1-4	61



技术参数

Technical Data

P ₁ = 2.2kW								
NA rpm	M ₂ Nm	i	Fr ₂ MAX[N]	f _s	Type	Gear unit	Motor size	 Kg
27	775	52.07	10300	1.05	R	77	100L1-4	55
31	685	45.81	11000	1.20	RF	77	100L1-4	61
33	645	43.26	11300	1.25				
38	550	36.83	11800	1.50	R	77	100L1-4	55
42	500	33.47	12100	1.65	RF	77	100L1-4	61
49	430	29.00	12100	1.90				
56	375	25.23	11700	2.1				
60	350	23.37	11400	2.4				
66	320	21.43	11200	2.6				
75	280	18.80	10800	2.8	R	77	100L1-4	54
79	265	17.82	10600	2.9	RF	77	100L1-4	60
90	230	15.60	10200	3.2				
100	210	14.05	9910	3.4				
35	595	39.88	7630	1.00				
38	560	37.50	8020	1.00	R	67	100L1-4	49
44	480	32.27	8750	1.10	RF	67	100L1-4	52
49	430	28.83	9140	1.20				
60	350	23.44	9140	1.60				
71	295	19.89	8760	2.0				
79	270	17.95	8530	2.2				
89	235	15.79	8240	2.4				
95	220	14.91	8110	2.5	R	67	100L1-4	48
111	189	12.70	7760	2.8	RF	67	100L1-4	51
122	172	11.54	7560	2.9				
141	149	10.00	7250	3.2				
162	130	8.70	6960	3.4				
181	116	7.79	6760	3.3				
38	555	37.30	4490	0.80				
40	525	35.07	5110	0.85	R	57	100L1-4	43
47	450	30.18	5030	1.00	RF	57	100L1-4	46
52	400	26.97	4960	1.10				
64	325	21.93	4800	1.40				
76	275	18.60	4660	1.60				
84	250	16.79	4570	1.80				
95	220	14.77	4450	2.0				
101	210	13.95	4390	2.1	R	57	100L1-4	42
119	177	11.88	4230	2.3	RF	57	100L1-4	45
131	161	10.79	4140	2.4				
151	139	9.35	4000	2.7				
156	135	9.06	3980	2.8				
177	119	7.97	3850	3.0				
107	197	26.31	4340	2.3	R	57	90L-2	35
112	187	24.99	4290	2.4	RF	57	90L-2	38



技术参数

Technical Data

P ₁ = 2.2kW								
NA rpm	M ₂ Nm	i	Fr ₂ MAX[N]	f _s	Type	Gear unit	Motor size	 Kg
128	164	21.93	4160	2.8				
151	139	18.60	3990	3.2	R	57	90L-2	35
167	126	16.79	3890	3.6	RF	57	90L-2	38
190	111	14.77	3760	3.9				
201	104	13.95	3710	4.1				
<hr/>								
73	285	19.27	3550	1.05				
87	240	16.22	3460	1.15				
97	215	14.56	3400	1.20				
112	187	12.54	3310	1.35				
120	176	11.79	3270	1.40				
139	151	10.15	3160	1.50				
155	135	9.07	3090	1.65	R	47	100L1-4	37
176	119	8.01	3000	1.70	RF	47	100L1-4	37
182	116	7.76	2910	1.40				
203	104	6.96	2840	1.55				
235	89	6.00	2740	1.75				
250	84	5.64	2700	1.85				
291	72	4.85	2600	2.1				
325	65	4.34	2530	2.3				
368	57	3.83	2440	2.5				
<hr/>								
121	174	23.28	3260	1.70				
129	163	21.81	3220	1.85				
146	144	19.27	3130	2.1				
157	134	17.89	3080	2.2				
173	121	16.22	3010	2.3	R	47	90L-2	30
193	109	14.56	2930	2.4	RF	47	90L-2	30
224	94	12.54	2830	2.7				
238	88	11.79	2780	2.8				
277	76	10.15	2680	3.0				
310	68	9.07	2600	3.2				
351	60	8.01	2510	3.4				
<hr/>								
90	230	15.60	1070	0.85	R	37	100L1-4	31
106	198	13.25	1660	0.95	RF	37	100L1-4	33
119	176	11.83	1990	1.05				
<hr/>								
140	151	10.11	2360	1.15				
149	141	9.47	2480	1.20				
177	119	7.97	2750	1.30				
211	99	6.67	2470	1.45	R	37	100L1-4	31
249	84	5.67	2570	1.70	RF	37	100L1-4	33
279	75	5.06	2500	1.80				
326	64	4.32	2410	1.95				
348	60	4.05	2370	2.0				
414	51	3.41	2270	2.2				



技术参数

Technical Data

P ₁ = 2.2kW								
NA rpm	M ₂ Nm	i	Fr ₂ MAX[N]	f _s	Type	Gear unit	Motor size	 Kg
146	144	19.31	2440	1.40	R	37	90L-2	25
156	135	18.05	2560	1.50	RF	37	90L-2	27
180	117	15.60	2780	1.70				
212	99	13.25	2700	1.9				
237	89	11.83	2630	2.1				
278	76	10.11	2540	2.3				
297	71	9.47	2500	2.4				
352	60	7.97	2390	2.6	R	37	90L-2	25
421	50	6.67	2260	2.9	RF	37	90L-2	27
496	42	5.67	2170	3.4				
555	38	5.06	2100	3.6				
650	32	4.32	2010	3.9				
694	30	4.05	1980	4.0				
824	26	3.41	1880	4.4				
139	151	10.13	1120	0.80				
214	98	6.59	1130	1.10				
252	83	5.60	1390	1.20	R	27	100L1-4	26
282	75	5.00	1540	1.30	RF	27	100L1-4	26
330	64	4.27	1540	1.35				
353	60	4.00	1520	1.45				
418	50	3.37	1470	1.55				
212	99	13.28	1710	1.30				
237	89	11.86	1680	1.45				
277	76	10.13	1640	1.60				
344	61	8.16	1520	1.90				
369	57	7.63	1500	1.95	R	27	100L1-4	20
426	49	6.59	1460	2.2	RF	27	100L1-4	19
502	42	5.60	1410	2.4				
562	37	5.00	1380	2.5				
658	32	4.27	1330	2.7				
703	30	4.00	1310	2.8				
834	25	3.37	1250	3.1				
298	70	4.73	5180	1.75				
349	60	4.04	4950	2.4				
381	55	3.70	4820	2.8				
434	48	3.25	4640	3.8				
458	46	3.08	4560	4.2	RX	77	100L1-4	45
523	40	2.70	4380	5.4	RXF	77	100L1-4	48
581	36	2.43	4250	5.9				
662	32	2.13	4080	6.3				
750	28	1.88	3920	6.7				
846	25	1.67	3780	7.0				
991	21	1.42	3590	7.3				



技术参数

Technical Data

P ₁ = 2.2kW								
NA rpm	M ₂ Nm	i	Fr ₂ MAX[N]	f _s	Type	Gear unit	Motor size	 Kg
374	56	3.77	3280	1.55				
441	48	3.20	3130	2.1				
488	43	2.89	3050	2.5				
555	38	2.54	2940	3.1				
588	36	2.40	2890	3.4	RX	67	100L1-4	36
690	30	2.04	2760	4.4	RXF	67	100L1-4	40
759	28	1.86	2680	4.6				
876	24	1.61	2570	4.8				
1005	21	1.40	2460	5.0				
450	47	3.14	2450	1.40				
534	39	2.64	2340	1.75				
595	35	2.37	2280	1.95				
691	30	2.04	2190	2.3	RX	57	100L1-4	33
734	29	1.92	2150	2.4	RXF	57	100L1-4	35
853	25	1.65	2060	2.8				
955	22	1.48	1990	3.1				
1080	19	1.30	1930	3.3				
P ₁ = 3.0kW								
1.2	21200	1123	120000	0.85				
1.4	18900	999	120000	0.95				
1.6	16300	861	120000	1.10	R	167 R97	100L2-4	770
1.8	14400	760	120000	1.25	RF	167 R97	100L2-4	780
2.1	12200	656	120000	1.50				
2.8	9330	503	120000	1.95				
2.6	9990	533	67800	1.30				
3.0	8610	462	69600	1.50				
3.3	8060	426	70200	1.60	R	147 R87	100L2-4	465
3.8	6960	368	71400	1.85	RF	147 R87	100L2-4	470
4.3	6150	326	72100	2.1				
5.0	5230	280	72800	2.5				
1.6	16900	889	21900	0.75				
1.8	14900	784	52000	0.85				
2.0	13200	695	62300	1.00	R	147 R77	100L2-4	440
2.3	11800	619	64900	1.10	RF	147 R77	100L2-4	450
2.5	10600	558	66900	1.20				
2.9	9280	490	48100	0.85				
3.3	8100	428	53200	1.00				
3.7	7260	381	54900	1.10				
4.3	6160	323	56800	1.30	R	137 R77	100L2-4	310
4.8	5540	291	57700	1.45	RF	137 R77	100L2-4	335
5.5	4840	255	58600	1.65				
6.3	4240	223	59300	1.90				



技术参数

Technical Data

P ₁ = 3.0kW								
NA rpm	M ₂ Nm	i	Fr ₂ MAX[N]	f _s	Type	Gear unit	Motor size	 Kg
2.7	9990	517	34100	0.80	R	137 R77	100L2-4	300
3.1	8760	453	50700	0.90	RF	137 R77	100L2-4	325
5.5	4790	253	23500	0.90	R	107 R77	100L2-4	225
6.5	4060	214	30700	1.05	RF	107 R77	100L2-4	230
7.5	3550	187	33000	1.20				
5.5	4930	256	17400	0.85	R	107 R77	100L2-4	215
					RF	107 R77	100L2-4	225
3.2	8860	222.60	50300	0.90				
3.8	7500	188.45	54400	1.05	R	137	132M-8	305
4.1	6940	174.40	55500	1.15	RF	137	132M-8	325
4.6	6220	156.31	56700	1.30				
5.1	5620	141.12	57600	1.40				
5.6	5100	128.18	58300	1.55	R	137	132M-8	305
6.3	4520	113.72	59000	1.75	RF	137	132M-8	325
7.0	4110	103.20	59400	1.95				
8.1	3530	88.70	59900	2.3				
4.2	6780	222.60	55800	1.20	R	137	132S-6	295
5.0	5740	188.45	57400	1.40	RF	137	132S-6	320
5.4	5320	174.40	58000	1.50				
6.0	4760	156.31	58700	1.70				
6.7	4300	141.12	59200	1.85				
7.3	3910	128.18	59600	2.1	R	137	132S-6	295
8.3	3470	113.72	60000	2.3	RF	137	132S-6	320
9.1	3150	103.20	60200	2.5				
5.9	4840	158.68	21600	0.90	R	107	132S-6	195
6.6	4320	141.83	29300	1.00	RF	107	132S-6	205
7.4	3890	127.68	31500	1.10				
6.1	4710	229.95	26500	0.90	R	107	100L2-4	185
6.9	4160	203.16	30200	1.05	RF	107	100L2-4	190
8.1	3530	172.34	33100	1.20				
8.8	3250	158.68	34100	1.30				
9.9	2900	141.83	35300	1.50				
11	2610	127.68	36000	1.65				
12	2370	115.63	36300	1.80				
14	2100	102.53	36700	2.1				
15	1900	92.70	36900	2.3				
18	1610	78.57	35900	2.7				
19	1490	72.88	35200	2.9				
9.3	3090	150.78	16200	0.95	R	97	100L2-4	125
11	2590	126.75	23600	1.15	RF	97	100L2-4	145
12	2380	116.48	24700	1.25				
14	2120	103.44	25900	1.40				



技术参数

Technical Data

P ₁ = 3.0kW								
NA rpm	M ₂ Nm	i	Fr ₂ MAX[N]	f _s	Type	Gear unit	Motor size	 Kg
15	1890	92.48	26800	1.60				
17	1700	83.15	27300	1.75				
19	1480	72.17	27700	2.0				
21	1330	65.21	27000	2.3				
23	1230	59.92	26400	2.5	R	97	100L2-4	125
26	1090	53.21	25600	2.8	RF	97	100L2-4	145
29	970	47.58	24800	3.1				
33	880	42.78	24000	3.4				
38	760	37.13	23100	4.0				
42	680	33.25	22400	4.3				
15	1910	93.38	13630	0.80				
17	1680	81.92	16000	0.90	R	87	100L2-4	86
19	1490	72.57	17400	1.05	RF	87	100L2-4	93
22	1300	63.68	18400	1.20				
23	1230	60.35	18800	1.25				
27	1080	52.82	19500	1.45				
29	970	47.58	19900	1.60	R	87	100L2-4	86
34	850	41.74	19400	1.80	RF	87	100L2-4	93
38	755	36.84	18700	2.1				
43	670	32.66	18100	2.3				
50	570	27.88	17400	2.6				
41	705	34.40	18400	2.1				
45	640	31.40	17900	2.4				
50	570	27.84	17400	2.7				
60	480	23.40	16500	3.2	R	87	100L2-4	85
65	440	21.51	16100	3.4	RF	87	100L2-4	92
73	390	19.10	15600	3.7				
82	350	17.08	15100	4.0				
91	315	15.35	14600	4.3				
31	940	45.81	8670	0.85				
32	890	43.26	9270	0.95	R	77	100L2-4	59
38	755	36.83	10500	1.10	RF	77	100L2-4	65
42	685	33.47	11000	1.20				
48	595	29.00	11600	1.40	R	77	100L2-4	59
55	515	25.23	11300	1.50	RF	77	100L2-4	65
60	480	23.37	11100	1.70				
65	440	21.43	10800	1.85				
74	385	18.80	10500	2.0				
79	365	17.82	10300	2.1	R	77	100L2-4	58
90	320	15.60	9980	2.3	RF	77	100L2-4	64
100	290	14.05	9700	2.5				
114	250	12.33	9350	2.7				
129	225	10.88	9030	3.0				



技术参数

Technical Data

P ₁ = 3.0kW								
NA rpm	M ₂ Nm	i	Fr ₂ MAX[N]	f _s	Type	Gear unit	Motor size	 Kg
145	197	9.64	8720	3.2				
163	176	8.59	8500	3.6	R	77	100L2-4	58
181	158	7.74	8240	3.9	RF	77	100L2-4	64
206	139	6.79	7920	4.2				
60	480	23.44	8730	1.15				
70	405	19.89	8420	1.45				
78	365	17.95	8230	1.60				
89	325	15.79	7980	1.75	R	67	100L2-4	52
94	305	14.91	7860	1.80	RF	67	100L2-4	55
110	260	12.70	7550	2.0				
121	235	11.54	7360	2.1				
140	205	10.00	7090	2.3				
52	550	26.97	4330	0.80	R	57	100L2-4	47
					RF	57	100L2-4	50
64	450	21.93	4380	1.00	R	57	100L2-4	46
75	380	18.60	4300	1.20	RF	57	100L2-4	49
83	345	16.79	4250	1.30				
95	300	14.77	4160	1.45				
100	285	13.95	4130	1.50				
118	245	11.88	4010	1.65				
130	220	10.79	3940	1.75				
150	191	9.35	3820	1.95				
155	185	9.06	3810	2.0	R	57	100L2-4	46
176	163	7.97	3700	2.2	RF	57	100L2-4	49
186	154	7.53	3650	2.3				
218	131	6.41	3520	2.6				
240	119	5.82	3430	2.7				
277	103	5.05	3310	3.0				
319	90	4.39	3190	3.1				
128	225	21.93	3950	2.0				
151	190	18.60	3820	2.4				
167	172	16.79	3730	2.6				
190	151	14.77	3620	2.9	R	57	100L-2	42
201	143	13.95	3570	3.0	RF	57	100L-2	45
236	122	11.88	3440	3.3				
259	110	10.79	3360	3.5				
86	330	16.22	2030	0.85	R	47	100L2-4	41
96	300	14.56	2500	0.90	RF	47	100L2-4	41
112	255	12.54	3040	0.95				
119	240	11.79	3040	1.00				
138	210	10.15	2970	1.10	R	47	100L2-4	41
154	186	9.07	2910	1.20	RF	47	100L2-4	41
175	164	8.01	2840	1.25				



技术参数

Technical Data

P ₁ = 3.0kW								
NA rpm	M ₂ Nm	i	Fr ₂ MAX[N]	f _s	Type	Gear unit	Motor size	 Kg
181	159	7.76	2740	1.05				
201	143	6.96	2680	1.10				
233	123	6.00	2610	1.25	R	47	100L2-4	41
248	115	5.64	2580	1.35	RF	47	100L2-4	41
288	99	4.85	2490	1.50				
323	89	4.34	2430	1.65				
365	78	3.83	2360	1.85				
237	121	11.79	2670	2.0				
276	104	10.15	2580	2.2				
309	93	9.07	2510	2.4				
349	82	8.01	2430	2.5				
361	79	7.76	2370	2.1	R	47	100L-2	37
402	71	6.96	2310	2.2	RF	47	100L-2	37
467	61	6.00	2220	2.5				
496	58	5.64	2190	2.7				
577	50	4.85	2100	3.0				
646	44	4.34	2040	3.3				
731	39	3.83	1970	3.7				
139	205	10.11	780	0.80	R	37	100L2-4	35
148	194	9.47	1010	0.85	RF	37	100L2-4	37
176	163	7.97	1510	0.95				
210	137	6.67	1250	1.05				
247	116	5.67	1630	1.25				
277	104	5.06	1830	1.30	R	37	100L2-4	35
324	88	4.32	2070	1.45	RF	37	100L2-4	37
346	83	4.05	2140	1.45				
411	70	3.41	2180	1.60				
277	103	10.11	2340	1.65				
296	97	9.47	2380	1.70				
351	82	7.97	2290	1.90				
420	68	6.67	2170	2.1	R	37	100L-2	31
494	58	5.67	2090	2.5	RF	37	100L-2	33
553	52	5.06	2030	2.6				
648	44	4.32	1950	2.9				
692	41	4.05	1920	3.0				
821	35	3.41	1840	3.2				
250	115	5.60	360	0.85				
280	102	5.00	615	0.95	R	27	100L2-4	30
328	87	4.27	910	1.00	RF	27	100L2-4	30
350	82	4.00	1010	1.05				
415	69	3.37	1230	1.15				
425	67	6.59	1260	1.55	R	27	100L-2	26
500	57	5.60	1330	1.75	RF	27	100L-2	26



技术参数

Technical Data

P ₁ = 3.0kW								
NA rpm	M ₂ Nm	i	Fr ₂ MAX[N]	f _s	Type	Gear unit	Motor size	 Kg
560	51	5.00	1300	1.85				
656	44	4.27	1260	2.0	R	27	100L-2	26
700	41	4.00	1240	2.1	RF	27	100L-2	26
831	35	3.37	1200	2.3				
217	132	6.45	7130	1.45				
252	114	5.56	6830	2.0	RX	87	100L2-4	66
276	104	5.07	6650	2.4	RXF	87	100L2-4	71
311	92	4.50	6430	3.2				
370	77	3.78	6100	3.9				
296	97	4.73	5050	1.25				
347	83	4.04	4830	1.75	RX	77	100L2-4	49
378	76	3.70	4720	2.0	RXF	77	100L2-4	52
431	67	3.25	4550	2.7				
455	63	3.08	4480	3.1				
371	77	3.77	3150	1.15				
438	66	3.20	3030	1.55				
485	59	2.89	2950	1.80				
551	52	2.54	2850	2.3				
583	49	2.40	2810	2.5	RX	67	100L2-4	40
685	42	2.04	2690	3.2	RXF	67	100L2-4	44
754	38	1.86	2610	3.3				
870	33	1.61	2510	3.5				
1000	29	1.40	2410	3.6				
446	64	3.14	2330	1.00				
530	54	2.64	2240	1.30				
591	49	2.37	2180	1.40				
686	42	2.04	2100	1.65	RX	57	100L2-4	37
729	39	1.92	2070	1.75	RXF	57	100L2-4	39
847	34	1.65	1990	2.0				
948	30	1.48	1930	2.3				
1075	27	1.30	1870	2.4				
P ₁ = 4.0kW								
1.7	21500	861	120000	0.85				
1.9	19000	760	120000	0.95				
2.2	16100	656	120000	1.10	RX	167 R97	112M-4	780
2.8	12400	503	120000	1.45	RXF	167 R97	112M-4	780
3.8	9260	376	120000	1.95				
4.2	8240	335	120000	2.2				
2.7	13200	533	62200	1.00				
3.1	11400	462	65600	1.15				
3.3	10600	426	66800	1.20	R	147 R87	112M-4	470
3.9	9190	368	68900	1.40	RF	147 R87	112M-4	475
4.4	8130	326	70200	1.60				



技术参数

Technical Data

P ₁ = 4.0kW								
NA rpm	M ₂ Nm	i	Fr ₂ MAX[N]	f _s	Type	Gear unit	Motor size	 Kg
5.1	6920	280	71400	1.90				
5.7	6110	247	72100	2.1	R	147 R87	112M-4	470
6.7	5280	214	72800	2.5	RF	147 R87	112M-4	475
7.5	4670	189	73200	2.8				
9.0	3920	159	73600	3.3				
2.3	15500	619	43200	0.85				
2.5	14000	558	60500	0.95	R	147 R77	112M-4	445
2.9	12300	489	64100	1.05	RF	147 R77	112M-4	455
3.4	10400	415	67200	1.25				
3.7	9570	381	42700	0.85				
4.4	8120	323	53100	1.00	R	137 R77	112M-4	315
4.9	7310	291	54800	1.10	RF	137 R77	112M-4	340
5.6	6390	255	56400	1.25				
6.4	5600	223	57600	1.45				
3.8	9560	376	43000	0.85				
4.2	8600	339	51400	0.95	R	137 R77	112M-4	305
4.8	7540	297	54300	1.05	RF	137 R77	112M-4	330
7.6	4680	187	27200	0.90				
					R	107 R77	112M-4	230
					RF	107 R77	112M-4	235
7.3	4890	193	19000	0.90				
8.2	4380	172	29000	1.00	R	107 R77	112M-4	225
					RF	107 R77	112M-4	230
4.4	8660	163.31	69500	1.50				
4.9	7790	146.91	70500	1.65	R	147	160M1-8	440
6.0	6360	119.86	71900	2.0	RF	147	160M1-8	450
6.6	5800	109.31	72400	2.2				
4.1	9250	174.40	48400	0.85				
4.6	8290	156.31	52700	0.95				
5.1	7490	141.12	54400	1.05	R	137	160M1-8	310
5.6	6800	128.18	55700	1.20	RF	137	160M1-8	335
6.3	6030	113.72	57000	1.35				
7.0	5470	103.20	57800	1.45				
4.3	8860	222.60	50300	0.90				
5.1	7500	188.45	54400	1.05				
5.5	6940	174.40	55500	1.15	R	137	132M1-6	305
6.1	6220	156.31	56700	1.30	RF	137	132M1-6	325
6.8	5620	141.12	57600	1.40				
7.5	5100	128.18	58300	1.55				
8.4	4520	113.72	59000	1.75				
9.3	4110	103.20	59400	1.95	R	137	132M1-6	305
11	3530	88.70	59900	2.3	RF	137	132M1-6	325



技术参数

Technical Data

P ₁ = 4.0kW								
NA rpm	M ₂ Nm	i	Fr ₂ MAX[N]	f _s	Type	Gear unit	Motor size	 Kg
8.2	4640	172.34	27500	0.95				
9.0	4270	158.68	29600	1.00				
10	3820	141.83	31900	1.15				
11	3430	127.68	33400	1.25				
12	3110	115.63	34600	1.40				
14	2760	102.53	35700	1.55	R	107	112M-4	190
15	2490	92.70	36200	1.70	RF	107	112M-4	195
18	2110	78.57	34900	2.0				
19	1960	72.88	34200	2.2				
22	1760	65.60	33200	2.4				
24	1600	59.41	32300	2.7				
27	1420	52.68	31300	3.0				
12	3130	116.48	13800	0.95				
14	2780	103.44	22400	1.10				
15	2490	92.48	24100	1.20				
17	2240	83.15	25400	1.35				
20	1940	72.17	26600	1.55				
22	1750	65.21	26000	1.70	R	97	112M-4	135
24	1610	59.92	25500	1.85	RF	97	112M-4	150
27	1430	53.21	24700	2.1				
30	1280	47.58	24000	2.3				
33	1150	42.78	23400	2.6				
38	1000	37.13	22500	3.0				
43	890	33.25	21800	3.2				
44	860	32.05	21600	3.0				
52	730	27.19	20600	3.5	R	97	112M-4	130
57	675	25.03	20100	4.2	RF	97	112M-4	150
63	600	22.37	19500	4.5				
71	540	20.14	18900	4.8				
22	1710	63.68	13300	0.90	R	87	112M-4	91
24	1620	60.35	13900	0.95	RF	87	112M-4	98
27	1420	52.82	15200	1.10				
30	1280	47.58	16000	1.20				
34	1120	41.74	16800	1.40	R	87	112M-4	91
39	990	36.84	17400	1.55	RF	87	112M-4	98
43	880	32.66	17500	1.75				
51	750	27.88	16800	2.0				
41	930	34.40	17600	1.60				
45	840	31.40	17400	1.85				
51	750	27.84	16800	2.1	R	87	112M-4	90
61	630	23.40	16100	2.5	RF	87	112M-4	97
66	580	21.51	15700	2.6				
74	515	19.10	15200	2.8				
83	460	17.08	14700	3.0				



技术参数

Technical Data

P ₁ = 4.0kW								
NA rpm	M ₂ Nm	i	Fr ₂ MAX[N]	f _s	Type	Gear unit	Motor size	 Kg
92	415	15.35	14300	3.2	R	87	112M-4	90
107	360	13.33	13700	3.6	RF	87	112M-4	97
119	320	11.93	13300	3.8				
39	990	36.83	4070	0.85				
42	900	33.47	9100	0.90	R	77	112M-4	65
49	780	29.00	10300	1.05	RF	77	112M-4	71
56	680	25.23	10800	1.15				
61	630	23.37	10600	1.30				
66	575	21.43	10400	1.40				
76	505	18.80	10100	1.55				
80	480	17.82	9950	1.65				
91	420	15.60	9630	1.75				
101	380	14.05	9380	1.90				
115	330	12.33	9070	2.1	R	77	112M-4	64
131	295	10.88	8780	2.3	RF	77	112M-4	70
147	260	9.64	8500	2.4				
165	230	8.59	8320	2.7				
183	210	7.74	8070	2.9				
209	183	6.79	7770	3.2				
237	161	5.99	7490	3.4				
267	143	5.31	7230	3.6				
71	535	19.89	7960	1.10				
79	485	17.95	7800	1.20				
90	425	15.79	7600	1.30				
95	400	14.91	7510	1.35				
112	340	12.70	7240	1.50				
123	310	11.54	7080	1.60				
142	270	10.00	6840	1.75	R	67	112M-4	59
163	235	8.70	6600	1.90	RF	67	112M-4	62
182	210	7.79	6440	1.80				
193	198	7.36	6340	1.85				
227	169	6.27	6070	1.95				
249	153	5.70	5920	2.0				
288	133	4.93	5680	2.2				
331	116	4.29	5460	2.3				
76	500	18.60	3520	0.90	R	57	112M-4	53
85	450	16.79	3830	1.00	RF	57	112M-4	56
96	395	14.77	3800	1.10				
102	375	13.95	3780	1.15				
120	320	11.88	3710	1.25				
132	290	10.79	3660	1.35	R	57	112M-4	53
152	250	9.35	3580	1.45	RF	57	112M-4	56
157	245	9.06	3590	1.55				
178	215	7.97	3500	1.65				



技术参数

Technical Data

P ₁ = 4.0kW								
NA rpm	M ₂ Nm	i	Fr ₂ MAX[N]	f _s	Type	Gear unit	Motor size	 Kg
189	205	7.53	3470	1.75				
222	172	6.41	3350	1.95	R	57	112M-4	53
244	157	5.82	3280	2.0	RF	57	112M-4	56
281	136	5.05	3180	2.3				
323	118	4.39	3070	2.4				
<hr/>								
140	275	10.15	1960	0.85				
157	245	9.07	2350	0.90				
177	215	8.01	2640	0.95				
204	187	6.96	2480	0.85	R	47	112M-4	48
237	161	6.00	2430	0.95	RF	47	112M-4	48
252	152	5.64	2410	1.00				
293	131	4.85	2350	1.15				
327	117	4.34	2300	1.25				
371	103	3.83	2250	1.40				
<hr/>								
176	215	16.22	2640	1.25				
196	195	14.56	2600	1.35				
228	168	12.54	2540	1.50				
242	158	11.79	2510	1.55				
282	136	10.15	2440	1.70				
315	121	9.07	2390	1.80	R	47	112M-2	48
357	107	8.01	2320	1.90	RF	47	112M-2	48
369	104	7.76	2250	1.55				
411	93	6.96	2200	1.70				
477	80	6.00	2130	1.95				
507	75	5.64	2100	2.1				
589	65	4.85	2020	2.3				
660	58	4.34	1970	2.5				
746	51	3.83	1910	2.8				
<hr/>								
255	150	5.56	6630	1.50				
280	137	5.07	6470	1.85	RX	87	112M-4	71
316	121	4.50	6260	2.4	RXF	87	112M-4	76
375	102	3.78	5960	3.0				
<hr/>								
351	109	4.04	4670	1.30				
383	100	3.70	4560	1.55				
437	87	3.25	4410	2.1				
461	83	3.08	4350	2.3				
527	73	2.70	4190	3.0	RX	77	112M-4	55
585	65	2.43	4070	3.3	RXF	77	112M-4	58
667	57	2.13	3920	3.5				
755	51	1.88	3780	3.7				
852	45	1.67	3650	3.9				
998	38	1.42	3480	4.1				
<hr/>								
444	86	3.20	2870	1.15	RX	67	112M-4	47
492	78	2.89	2810	1.35	RXF	67	112M-4	51



技术参数

Technical Data

P ₁ = 4.0kW								
NA rpm	M ₂ Nm	i	Fr ₂ MAX[N]	f _s	Type	Gear unit	Motor size	 Kg
559	68	2.54	2730	1.75				
592	65	2.40	2690	1.90				
695	55	2.04	2580	2.4	RX	67	112M-4	47
765	50	1.86	2520	2.5	RXF	67	112M-4	51
883	43	1.61	2420	2.6				
1015	38	1.40	2330	2.8				
538	71	2.64	1670	0.95				
599	64	2.37	1780	1.10				
696	55	2.04	1910	1.25	RX	57	112M-4	44
740	52	1.92	1940	1.35	RXF	57	112M-4	46
859	44	1.65	1900	1.55				
962	40	1.48	1840	1.70				
1090	35	1.30	1790	1.80				
P ₁ = 5.5kW								
2.2	22200	656	120000	0.80				
2.5	19400	579	120000	0.95				
2.8	17000	503	120000	1.05				
3.3	14500	432	120000	1.25	R	167 R97	132S-4	780
3.8	12700	376	120000	1.40	RF	167 R97	132S-4	790
4.3	11300	335	120000	1.60				
4.7	10200	303	120000	1.75				
5.1	9360	279	120000	1.90				
3.1	15700	462	41200	0.85				
3.4	14600	426	55400	0.90				
3.9	12600	368	63500	1.05				
4.4	11100	326	66000	1.15	R	147 R87	132S-4	475
5.1	9520	280	68500	1.35	RF	147 R87	132S-4	480
5.8	8400	247	69900	1.55				
6.7	7250	214	71100	1.80				
7.6	6410	189	71900	2.0				
3.1	17000	229.71	120000	1.05				
3.8	13800	186.93	120000	1.30				
4.6	11300	153.07	120000	1.60	R	167	160M2-8	700
5.1	10400	139.98	120000	1.75	RF	167	160M2-8	700
5.8	9010	121.81	120000	2.0				
4.4	12100	163.31	64400	1.10				
4.8	10900	146.91	66500	1.20	R	147	160M2-8	445
5.9	8870	119.86	69300	1.45	RF	147	160M2-8	455
6.5	8090	109.31	70200	1.60				
5.9	8930	163.31	69200	1.45				
6.5	8040	146.91	70300	1.60	R	147	132M2-6	440
8.0	6560	119.86	71700	2.0	RF	147	132M2-6	450



技术参数

Technical Data

P ₁ = 5.5kW								
NA rpm	M ₂ Nm	i	Fr ₂ MAX[N]	f _s	Type	Gear unit	Motor size	 Kg
8.8	5980	109.31	72200	2.2	R	147	132M2-6	440
10	5180	94.60	72800	2.5	RF	147	132M2-6	450
12	4570	83.47	73200	2.9				
5.5	9480	128.18	44400	0.85				
6.2	8410	113.72	52200	0.95	R	137	160M2-8	315
6.9	7630	103.20	54200	1.05	RF	137	160M2-8	340
8.0	6560	88.70	56100	1.20				
5.5	9540	174.40	43300	0.85				
6.1	8550	156.31	51600	0.95				
6.8	7720	141.12	54000	1.05	R	137	132M2-6	310
7.5	7010	128.18	55300	1.15	RF	137	132M2-6	335
8.4	6220	113.72	56700	1.30				
9.3	5650	103.20	57600	1.40				
6.4	8180	222.60	53000	1.00				
7.6	6920	188.45	55500	1.15	R	137	132S-4	295
8.2	6410	174.40	56400	1.25	RF	137	132S-4	320
9.2	5740	156.31	57400	1.40				
10	5180	141.12	58200	1.55				
11	4710	128.18	58800	1.70				
13	4180	113.72	59300	1.90				
14	3790	103.20	59700	2.1				
16	3260	88.70	60200	2.5				
18	2970	80.91	60400	2.7	R	137	132S-4	295
19	2700	73.49	60500	3.0	RF	137	132S-4	320
22	2390	65.20	60700	3.3				
24	2170	59.17	60900	3.7				
28	1870	50.86	61000	4.3				
11	4690	127.68	27100	0.90				
12	4250	115.63	29800	1.00				
14	3770	102.53	32100	1.15				
15	3400	92.70	33500	1.25				
18	2890	78.57	33500	1.50	R	107	132S-4	195
20	2680	72.88	32900	1.60	RF	107	132S-4	205
22	2410	65.60	32100	1.80				
24	2180	59.41	31300	1.95				
27	1930	52.68	30300	2.2				
30	1750	47.63	29500	2.5				
35	1480	40.37	28200	2.9				
17	3050	83.15	17600	1.00				
20	2650	72.17	21800	1.15				
22	2390	65.21	24600	1.25	R	97	132S-4	140
24	2200	59.92	24200	1.35	RF	97	132S-4	155
27	1950	53.21	23600	1.55				
30	1750	47.58	23000	1.70				



技术参数

Technical Data

P ₁ = 5.5kW								
NA rpm	M ₂ Nm	i	Fr ₂ MAX[N]	f _s	Structure	Gear unit	Motor size	 Kg
33	1570	42.78	22500	1.90				
39	1360	37.13	21700	2.2	R	97	132S-4	140
43	1220	33.25	21100	2.4	RF	97	132S-4	155
52	1010	27.58	20100	2.6				
45	1180	32.05	20900	2.2				
53	1000	27.19	20000	2.6				
57	920	25.03	19600	3.1	R	97	132S-4	135
64	820	22.37	19000	3.3	RF	97	132S-4	155
71	740	20.14	18400	3.5				
78	670	18.24	17900	3.7				
88	595	16.17	17300	4.0				
30	1750	47.58	15400	0.90				
34	1530	41.74	17000	1.00	R	87	132S-4	97
39	1350	36.84	17200	1.15	RF	87	132S-4	105
44	1200	32.66	16700	1.30				
51	1020	27.88	16100	1.45				
51	1020	27.84	16100	1.50				
61	860	23.40	15500	1.80				
66	790	21.51	15200	1.90				
75	700	19.10	14700	2.1				
84	625	17.08	14300	2.2				
93	565	15.35	13900	2.4	R	87	132S-4	96
107	490	13.33	13400	2.6	RF	87	132S-4	105
120	440	11.93	13000	2.8				
144	365	9.90	12300	3.3				
156	335	9.14	12200	3.6				
174	300	8.22	11800	3.8				
200	260	7.13	11300	4.1				
76	690	18.80	9240	1.15	R	77	132S-4	71
80	655	17.82	9400	1.20	RF	77	132S-4	77
92	575	15.60	9150	1.30				
102	515	14.05	8950	1.40				
116	455	12.33	8690	1.50				
131	400	10.88	8440	1.65				
148	355	9.64	8190	1.80				
166	315	8.59	8080	2.0	R	77	132S-4	71
185	285	7.74	7860	2.2	RF	77	132S-4	77
211	250	6.79	7580	2.3				
239	220	5.99	7320	2.5				
269	195	5.31	7070	2.6				
91	580	15.79	6610	0.95				
96	550	14.91	6900	1.00	R	67	132S-4	64
113	465	12.70	6810	1.10	RF	67	132S-4	67
124	425	11.54	6690	1.20				



技术参数

Technical Data

P ₁ = 5.5kW								
NA rpm	M ₂ Nm	i	Fr ₂ MAX[N]	f _s	Structure	Gear unit	Motor size	 Kg
143	365	10.00	6500	1.30				
164	320	8.70	6310	1.40				
183	285	7.79	6180	1.35				
194	270	7.36	6100	1.35	R	67	132S-4	64
228	230	6.27	5860	1.45	RF	67	132S-4	67
251	210	5.70	5720	1.50				
290	181	4.93	5510	1.60				
333	158	4.29	5310	1.70				
331	159	8.70	5300	2.8				
369	142	7.79	5160	2.7				
391	134	7.36	5080	2.8	R	67	132S1-2	64
460	114	6.27	4860	2.9	RF	67	132S1-2	67
506	104	5.70	4730	3.0				
584	90	4.93	4540	3.2				
671	78	4.29	4350	3.5				
97	545	14.77	1730	0.80				
103	510	13.95	2070	0.85	R	57	132S-4	58
120	435	11.88	2900	0.95	RF	57	132S-4	61
132	395	10.79	3270	1.00				
153	345	9.35	3240	1.10				
179	295	7.97	3220	1.20				
190	275	7.53	3200	1.25	R	57	132S-4	58
223	235	6.41	3120	1.40	RF	57	132S-4	61
246	215	5.82	3080	1.50				
283	185	5.05	3000	1.65				
326	161	4.39	2920	1.75				
308	171	9.35	2930	2.2				
361	145	7.97	2850	2.4				
383	137	7.53	2820	2.6	R	57	132S-4	58
449	117	6.41	2720	2.9	RF	57	132S-4	61
494	106	5.82	2660	3.0				
571	92	5.05	2560	3.3				
656	80	4.39	2470	3.5				
295	178	4.85	1870	0.85	R	47	132S-4	53
330	159	4.34	2110	0.90	RF	47	132S-4	53
373	141	3.83	2080	1.00				
230	230	12.54	1730	1.10				
244	215	11.79	1910	1.15				
284	185	10.15	2250	1.25				
318	165	9.07	2220	1.35	R	47	Y132S1-2	53
359	146	8.01	2170	1.40	RF	47	Y132S1-2	53
480	109	6.00	2000	1.45				
511	103	5.64	1970	1.50				
593	89	4.85	1920	1.70				



技术参数

Technical Data

P ₁ = 5.5kW								
NA rpm	M ₂ Nm	i	Fr ₂ MAX[N]	f _s	Structure	Gear unit	Motor size	 Kg
664	79	4.34	1870	1.85	R	47	132S1-2	53
752	70	3.83	1820	2.1	RF	47	132S1-2	53
216	245	6.63	10500	1.90				
255	205	5.61	9980	2.2	RX	107	132S-4	135
276	191	5.19	9760	3.7	RXF	107	132S-4	150
307	171	4.65	9460	4.1				
247	215	5.79	8380	1.95				
291	180	4.91	8010	2.2				
316	166	4.52	7820	3.6				
354	149	4.04	7580	4.0				
393	134	3.64	7350	4.5				
434	121	3.30	7140	4.9	RX	97	132S-4	105
489	107	2.92	6890	5.5	RXF	97	132S-4	110
541	97	2.64	6690	6.1				
638	82	2.24	6360	7.2				
731	72	1.96	6110	7.9				
874	60	1.64	5780	8.4				
1010	52	1.42	5530	8.8				
318	165	4.50	6040	1.75				
378	139	3.78	5770	2.2				
411	128	3.48	5640	3.2				
463	113	3.09	5460	3.6	RX	87	132S-4	77
518	101	2.76	5290	4.0	RXF	87	132S-4	82
576	91	2.48	5130	4.5				
664	79	2.15	4930	4.9				
440	119	3.25	4220	1.50				
464	113	3.08	4160	1.70				
530	99	2.70	4030	2.2				
589	89	2.43	3920	2.4	RX	77	132S-4	62
671	78	2.13	3780	2.6	RXF	77	132S-4	65
761	69	1.88	3660	2.7				
858	61	1.67	3540	2.8				
1005	52	1.42	3380	3.0				
563	93	2.54	2550	1.25				
596	88	2.40	2520	1.40				
700	75	2.04	2430	1.80	RX	67	132S-4	52
770	68	1.86	2380	1.85	RXF	67	132S-4	56
889	59	1.61	2300	1.95				
1020	51	1.40	2220	2.0				
700	75	2.04	665	0.90				
745	71	1.92	755	1.00				
866	61	1.65	940	1.15	RX	57	132S-4	49
969	54	1.48	1020	1.25	RXF	57	132S-4	51
1095	48	1.30	1160	1.30				



技术参数

Technical Data

P ₁ = 7.5kW								
NA rpm	M ₂ Nm	i	Fr ₂ MAX[N]	f _s	Structure	Gear unit	Motor size	 Kg
2.8	23400	503	120000	0.75				
3.3	19900	432	120000	0.90				
3.8	17500	376	120000	1.05	R	167 R97	132M-4	800
4.3	15600	335	120000	1.15	RF	167 R97	132M-4	810
4.7	14000	303	120000	1.30				
5.1	12900	279	120000	1.40				
4.4	15200	326	47300	0.85				
5.1	13000	280	62600	1.00				
5.8	11500	247	65400	1.15	R	147 R87	132M-4	495
6.7	9940	214	67900	1.30	RF	147 R87	132M-4	500
7.6	8790	189	69400	1.50				
9.0	7390	159	71000	1.75				
3.1	22900	229.71	120000	0.80				
3.9	18600	186.93	120000	0.95				
4.7	15200	153.07	120000	1.20	R	167	160L-8	730
5.1	13900	139.98	120000	1.30	RF	167	160L-8	740
5.9	12100	121.81	120000	1.50				
4.2	17100	229.71	120000	1.05	R	167	160M-6	700
5.1	13900	186.93	120000	1.30	RF	167	160M-6	700
6.3	11400	153.07	120000	1.60				
6.9	10400	139.98	120000	1.70				
7.9	9090	121.81	120000	2.0				
8.9	8020	107.49	120000	2.2	R	167	160M-6	700
10	6950	93.19	120000	2.6	RF	167	160M-6	700
12	6190	82.91	120000	2.9				
13	5500	73.70	120000	3.3				
14	5030	67.40	120000	3.6				
4.4	16200	163.31	32800	0.80				
4.9	14600	146.91	55100	0.90	R	147	160L-8	480
6.0	11900	119.86	64700	1.10	RF	147	160L-8	490
6.6	10900	109.31	66500	1.20				
5.9	12200	163.31	64200	1.05	R	147	160M-6	445
6.5	11000	146.91	66300	1.20	RF	147	160M-6	455
8.0	8940	119.86	69200	1.45				
8.8	8150	109.31	70100	1.60	R	147	160M-6	445
10	7060	94.60	71300	1.85	RF	147	160M-6	455
12	6230	83.47	72000	2.1				
7.6	9440	188.45	45300	0.85				
8.2	8730	174.40	50800	0.90	R	137	160M-6	305
9.2	7830	156.31	53700	1.00	RF	137	160M-6	325
10	7070	141.12	55200	1.15				



技术参数

Technical Data

P ₁ = 7.5kW								
NA rpm	M ₂ Nm	i	Fr ₂ MAX[N]	f _s	Structure	Gear unit	Motor size	 Kg
11	6420	128.18	56400	1.25				
13	5700	113.72	57500	1.40				
14	5170	103.20	58200	1.55				
16	4440	88.70	59100	1.80				
18	4050	80.91	59500	1.95	R	137	132M-4	305
19	3680	73.49	59800	2.2	RF	137	132M-4	325
22	3270	65.20	60100	2.5				
24	2960	59.17	60400	2.7				
28	2550	50.86	60600	3.1				
15	4640	92.70	27500	0.95				
18	3940	78.57	31300	1.10				
20	3650	72.88	31300	1.20				
22	3290	65.60	30600	1.30				
24	2980	59.41	30000	1.45	R	107	132M-4	215
27	2640	52.68	29200	1.65	RF	107	132M-4	225
30	2390	47.63	28500	1.80				
35	2020	40.37	27300	2.1				
41	1770	35.26	26400	2.4				
48	1480	29.49	25200	2.9				
46	1540	30.77	25500	2.8	R	107	132M-4	210
52	1380	27.58	24700	3.1				
57	1250	24.90	24100	3.5	RF	107	132M-4	215
63	1130	22.62	23400	3.8				
24	3000	59.92	19700	1.00				
27	2670	53.21	22200	1.15				
30	2380	47.58	21800	1.25	R	97	132M-4	160
33	2140	42.78	21300	1.40	RF	97	132M-4	175
39	1860	37.13	20700	1.60				
43	1670	33.25	20200	1.75	R	97	132M-4	160
52	1380	27.58	19400	1.95	RF	97	132M-4	175
45	1610	32.05	20000	1.60				
53	1360	27.19	19300	1.90				
57	1250	25.03	18900	2.3	R	97	132M-4	155
64	1120	22.37	18400	2.4	RF	97	132M-4	175
71	1010	20.14	17900	2.6				
78	910	18.24	17500	2.7				
39	1840	36.84	11500	0.85	R	87	132M-4	120
44	1640	32.66	15700	0.95				
51	1400	27.88	15200	1.05	RF	87	132M-4	125
51	1390	27.84	15200	1.10				
61	1170	23.40	14700	1.30	R	87	132M-4	120
66	1080	21.51	14500	1.40	RF	87	132M-4	125
75	960	19.10	14100	1.50				



技术参数

Technical Data

P ₁ = 7.5kW								
NA rpm	M ₂ Nm	i	Fr ₂ MAX[N]	f _s	Structure	Gear unit	Motor size	 Kg
84	860	17.08	13700	1.65				
93	770	15.35	12500	1.75				
107	670	13.33	12900	1.90				
120	600	11.93	12600	2.1				
144	495	9.90	12000	2.4	R	87	132M-4	120
156	460	9.14	11900	2.6	RF	87	132M-4	125
174	410	8.22	11600	2.8				
200	355	7.13	11100	3.0				
224	320	6.39	10800	3.2				
270	265	5.30	10200	3.4				
<hr/>								
76	940	18.80	5310	0.85				
80	890	17.82	5720	0.85				
92	780	15.60	6610	0.95				
102	705	14.05	7180	1.00				
116	615	12.33	7750	1.10				
131	545	10.88	8010	1.20	R	77	132M-4	92
148	485	9.64	7810	1.30	RF	77	132M-4	98
166	430	8.59	7620	1.45				
185	390	7.74	7590	1.55				
211	340	6.79	7340	1.70				
239	300	5.99	7110	1.80				
269	265	5.31	6890	1.90				
<hr/>								
113	635	12.70	4240	0.80				
124	580	11.54	4860	0.85				
143	500	10.00	5620	0.95				
164	435	8.70	5930	1.00				
183	390	7.79	5500	0.95	R	67	132M-4	87
194	370	7.36	5720	1.00	RF	67	132M-4	90
228	315	6.27	5600	1.05				
251	285	5.70	5480	1.10				
290	245	4.93	5300	1.15				
333	215	4.29	5130	1.25				
<hr/>								
179	400	7.97	980	0.90				
190	375	7.53	1280	0.95				
223	320	6.41	2020	1.05	R	57	132M-4	81
246	290	5.82	2380	1.10	RF	57	132M-4	84
283	255	5.05	2760	1.20				
326	220	4.39	2710	1.25				
<hr/>								
196	365	14.77	2580	1.20				
208	345	13.95	2780	1.25				
244	295	11.88	2780	1.40				
269	265	10.79	2750	1.45	R	57	132S2-2	87
310	230	9.35	2710	1.60	RF	57	132S2-2	90
364	197	7.97	2670	1.80				
385	186	7.53	2640	1.90				



技术参数

Technical Data

P ₁ = 7.5kW								
NA rpm	M ₂ Nm	i	Fr ₂ MAX[N]	f _s	Structure	Gear unit	Motor size	 Kg
452	158	6.41	2570	2.1				
498	144	5.82	2520	2.2	R	57	132S2-2	87
575	125	5.05	2440	2.5	RF	57	132S2-2	90
660	108	4.39	2370	2.6				
216	330	6.63	10100	1.40				
255	280	5.61	9690	1.60	RX	107	132M-4	155
276	260	5.19	9490	2.7	RXF	107	132M-4	170
307	235	4.65	9210	3.0				
340	210	4.20	8950	3.9				
247	290	5.79	8080	1.45				
291	245	4.91	7750	1.60				
316	225	4.52	7580	2.6	RX	97	132M-4	125
354	205	4.04	7360	2.9	RXF	97	132M-4	130
393	182	3.64	7160	3.3				
434	165	3.30	6960	3.6				
489	146	2.92	6730	4.1				
318	225	4.50	5760	1.30				
378	189	3.78	5530	1.60				
411	174	3.48	5420	2.3				
463	155	3.09	5260	2.6				
518	138	2.76	5110	2.9	RX	87	132M-4	99
576	124	2.48	4970	3.3	RXF	87	132M-4	105
664	108	2.15	4780	3.6				
741	97	1.93	4640	3.7				
894	80	1.60	4400	3.9				
1030	70	1.39	4230	4.2				
440	163	3.25	3820	1.10				
464	154	3.08	3890	1.25				
530	135	2.70	3820	1.60				
589	122	2.43	3730	1.75	RX	77	132M-4	83
671	107	2.13	3620	1.85	RXF	77	132M-4	86
761	94	1.88	3510	2.0				
858	84	1.67	3400	2.1				
1005	71	1.42	3260	2.2				
563	127	2.54	1500	0.95				
596	120	2.40	1610	1.00				
700	102	2.04	1810	1.30	RX	67	132M-4	75
770	93	1.86	1930	1.35	RXF	67	132M-4	79
889	81	1.61	2060	1.40				
1020	70	1.40	2080	1.50				



技术参数

Technical Data

P ₁ = 11 kW								
N _A rpm	M ₂ Nm	i	Fr ₂ MAX[N]	f _s	Structure	Gear unit	Motor size	 Kg
4.9	19600	295	120000	0.90				
5.3	18200	270	120000	1.00	R	167 R107	160M-4	860
6.3	15400	229	120000	1.15	RF	167 R107	160M-4	870
7.2	13400	200	120000	1.35				
8.5	11300	169	120000	1.60				
5.0	20000	291	120000	0.90	R	167 R107	160M-4	860
					RF	167 R107	160M-4	860
4.3	22800	335	120000	0.80	R	167 R97	160M-4	820
4.8	20500	303	120000	0.90	RF	167 R97	160M-4	820
5.2	18900	279	120000	0.95				
5.8	16800	247	22800	0.75				
6.7	14500	214	56000	0.90	R	147 R87	160M-4	510
7.6	12900	189	63000	1.00	RF	147 R87	160M-4	520
9.1	10800	159	66600	1.20				
5.1	20500	186.93	120000	0.90				
6.3	16700	153.07	120000	1.05	R	167	160L-6	730
6.9	15300	139.98	120000	1.20	RF	167	160L-6	740
7.9	13300	121.81	120000	1.35				
6.3	16800	229.71	120000	1.05	R	167	160M-4	700
7.7	13600	186.93	120000	1.30	RF	167	160M-4	700
9.4	11200	153.07	120000	1.60				
10	10200	139.98	120000	1.75				
12	8890	121.81	120000	2.0	R	167	160M-4	700
13	7840	107.49	120000	2.3	RF	167	160M-4	700
15	6800	93.19	120000	2.7				
17	6050	82.91	120000	3.0				
6.5	16100	146.91	35400	0.80				
8.0	13100	119.86	62400	1.00	R	147	160M-4	480
8.8	12000	109.31	64600	1.10	RF	147	160M-4	490
10	10400	94.60	67300	1.25				
12	9130	83.47	69000	1.40				
8.8	11900	163.31	64700	1.10	R	147	160M-4	445
9.8	10700	146.91	66700	1.20	RF	147	160M-4	455
12	8740	119.86	69400	1.50				
13	7970	109.31	70300	1.65				
15	6900	94.60	71400	1.90				
17	6090	83.47	72100	2.1	R	147	160M-4	445
20	5260	72.09	72800	2.5	RF	147	160M-4	455
22	4890	66.99	73000	2.7				
24	4460	61.09	73300	2.9				
27	3860	52.87	73600	3.4				



技术参数

Technical Data

P ₁ = 11 kW								
NA rpm	M ₂ Nm	i	Fr ₂ MAX[N]	f _s	Structure	Gear unit	Motor size	 Kg
10	10300	141.12	23300	0.80				
11	9350	128.18	46900	0.85				
13	8300	113.72	52700	0.95				
14	7530	103.20	54400	1.05				
16	6470	88.70	56300	1.25				
18	5900	80.91	57200	1.35				
20	5360	73.49	57900	1.50	R	137	160M-4	315
22	4760	65.20	58700	1.70	RF	137	160M-4	340
24	4320	59.17	59200	1.85				
28	3710	50.86	59800	2.2				
32	3240	44.39	60200	2.5				
38	2750	37.65	60500	2.9				
44	2400	32.91	60700	3.3				
22	4790	65.60	23700	0.90				
24	4330	59.41	27600	1.00				
27	3840	52.68	27100	1.10				
30	3470	47.63	26600	1.25	R	107	160M-4	230
36	2940	40.37	25700	1.45	RF	107	160M-4	235
41	2570	35.26	25000	1.65				
49	2150	29.49	24000	2.0				
47	2240	30.77	24200	1.90				
52	2010	27.58	23600	2.1				
58	1820	24.90	23100	2.4	R	107	160M-4	225
64	1650	22.62	22500	2.6	RF	107	160M-4	230
72	1460	20.07	21800	2.9				
79	1330	18.21	21300	3.2				
34	3120	42.78	14500	0.95				
39	2710	37.13	18900	1.10				
43	2430	33.25	18600	1.20				
52	2010	27.58	18000	1.35				
58	1830	25.03	17700	1.55				
64	1630	22.37	17300	1.65				
71	1470	20.14	16900	1.80				
79	1330	18.24	16600	1.90	R	97	160M-4	175
89	1180	16.17	16100	2.0	RF	97	160M-4	190
98	1070	14.62	15700	2.2				
116	900	12.39	15100	2.4				
133	790	10.83	14600	2.7				
155	675	9.29	14300	3.0				
172	610	8.39	13900	3.3				
202	520	7.12	13200	3.9				
232	455	6.21	12700	4.2				
67	1570	21.51	13200	0.95	R	87	160M-4	130
75	1390	19.10	13000	1.05	RF	87	160M-4	140
84	1250	17.08	12800	1.10				



技术参数

Technical Data

P ₁ = 11 kW								
NA rpm	M ₂ Nm	i	Fr ₂ MAX[N]	f _s	Structure	Gear unit	Motor size	 Kg
94	1120	15.35	12500	1.20				
108	970	13.33	12200	1.30				
121	870	11.93	11900	1.40				
145	720	9.90	11400	1.65	R	87	160M-4	130
158	665	9.14	11500	1.80	RF	87	160M-4	140
175	600	8.22	11200	1.95				
202	520	7.13	10800	2.1				
225	465	6.39	10400	2.2				
272	385	5.30	9910	2.4				
132	795	10.88	4250	0.85	R	77	160M-4	105
149	705	9.64	5000	0.90	RF	77	160M-4	110
186	565	7.74	4630	1.10				
212	495	6.79	5250	1.15	R	77	160M-4	105
240	435	5.99	5720	1.25	RF	77	160M-4	110
271	390	5.31	6090	1.30				
277	380	5.19	9000	1.85				
310	340	4.65	8770	2.1				
343	305	4.20	8560	2.7	RX	107	160M-4	170
377	280	3.81	8360	3.0	RXF	107	160M-4	185
425	245	3.38	8100	3.4				
469	225	3.07	7900	3.7				
545	193	2.64	7580	4.3				
318	330	4.52	7150	1.80				
356	295	4.04	6970	2.0				
396	265	3.64	6800	2.2				
437	240	3.30	6640	2.5				
493	215	2.92	6440	2.8	RX	97	160M-4	135
545	193	2.64	6280	3.1	RXF	97	160M-4	145
643	163	2.24	6000	3.6				
736	143	1.96	5790	4.0				
880	119	1.64	5500	4.2				
1015	103	1.42	5280	4.4				
414	255	3.48	5030	1.60				
466	225	3.09	4910	1.80	RX	87	160M-4	110
522	200	2.76	4790	2.0	RXF	87	160M-4	115
580	181	2.48	4680	2.2				
669	157	2.15	4530	2.5				
747	141	1.93	4400	2.5	RX	87	160M-4	110
900	117	1.60	4200	2.7	RXF	87	160M-4	115
1035	102	1.39	4050	2.9				
593	177	2.43	1890	1.20				
676	155	2.13	2140	1.30				
766	137	1.88	2330	1.35	RX	77	160M-4	96
864	122	1.67	2460	1.40	RXF	77	160M-4	99
1010	104	1.42	2580	1.50				



技术参数

Technical Data

P ₁ = 15kW								
NA rpm	M ₂ Nm	i	Fr ₂ MAX[N]	f _s	Structure	Gear unit	Motor size	 Kg
6.4	20800	229	120000	0.85	R	167 R107	160L-4	900
7.3	18200	200	120000	1.00	RF	167 R107	160L-4	910
8.6	15300	169	120000	1.20				
6.4	20900	227	120000	0.85	R	167 R107	160L-4	900
7.4	18200	198	120000	1.00	RF	167 R107	160L-4	900
6.3	22600	153.07	120000	0.80				
6.9	20700	139.98	120000	0.85	R	167	180L-6	770
8.0	18000	121.81	120000	1.00	RF	167	180L-6	770
9.0	15900	107.49	120000	1.15				
6.4	22500	229.71	120000	0.80	R	167	160L-4	730
7.8	18300	186.93	120000	1.00	RF	167	160L-4	740
9.5	15000	153.07	120000	1.20				
10	13700	139.98	120000	1.30				
12	12000	121.81	120000	1.50				
14	10500	107.49	120000	1.70	R	167	160L-4	730
16	9140	93.19	120000	1.95	RF	167	160L-4	740
18	8130	82.91	120000	2.2				
20	7230	73.70	120000	2.5				
22	6610	67.40	120000	2.7				
8.9	16100	109.31	34400	0.80				
10	14000	94.60	60600	0.95	R	147	180L-6	520
12	12300	83.47	64000	1.05	RF	147	180L-6	530
13	10600	72.09	66800	1.20				
14	9890	66.99	67900	1.30				
8.9	16000	163.31	36200	0.80				
9.9	14400	146.91	57400	0.90	R	147	160L-4	480
12	11800	119.86	65000	1.10	RF	147	160L-4	490
13	10700	109.31	66700	1.20				
15	9280	94.60	68800	1.40				
17	8190	83.47	70100	1.60				
20	7070	72.09	71300	1.85	R	147	160L-4	480
22	6570	66.99	71700	2.0	RF	147	160L-4	490
24	5990	61.09	72200	2.2				
28	5190	52.87	72800	2.5				
31	4580	46.65	73200	2.8				
14	10100	103.20	30700	0.80				
16	8700	88.70	51000	0.90	R	137	160L-4	355
18	7940	80.91	53500	1.00	RF	137	160L-4	380
20	7210	73.49	55000	1.10				
22	6400	65.20	56400	1.25				
25	5800	59.17	57300	1.40	R	137	160L-4	355
29	4990	50.86	58400	1.60	RF	137	160L-4	380



技术参数

Technical Data

P ₁ = 15kW								
NA rpm	M ₂ Nm	i	Fr ₂ MAX[N]	f _s	Structure	Gear unit	Motor size	 Kg
33	4360	44.39	59100	1.85				
39	3690	37.65	59800	2.2	R	137	160L-4	355
44	3230	32.91	60200	2.5	RF	137	160L-4	380
52	2730	27.83	60500	2.8				
31	4670	47.63	24500	0.90				
36	3960	40.37	23900	1.10	R	107	160L-4	270
41	3460	35.26	23400	1.25	RF	107	160L-4	275
50	2890	29.49	22600	1.50				
47	3020	30.77	22800	1.40				
53	2710	27.58	22400	1.60				
59	2440	24.90	21900	1.75				
65	2220	22.62	21400	1.95	R	107	160L-4	265
73	1970	20.07	20900	2.2	RF	107	160L-4	270
80	1790	18.21	20400	2.4				
93	1540	15.65	19700	2.8				
107	1340	13.66	19000	3.2				
53	2710	27.58	16500	1.00	R	97	160L-4	215
					RF	97	160L-4	230
58	2460	25.03	16300	1.15				
65	2200	22.37	16100	1.25				
72	1980	20.14	15800	1.30				
80	1790	18.24	15600	1.40				
90	1590	16.17	15200	1.50				
100	1430	14.62	14900	1.60	R	97	160L-4	210
118	1220	12.39	14400	1.80	RF	97	160L-4	230
135	1060	10.83	14000	1.95				
157	910	9.29	13800	2.2				
174	820	8.39	13400	2.5				
205	700	7.12	12800	2.9				
235	610	6.21	12400	3.1				
85	1680	17.08	11600	0.85				
95	1510	15.35	11500	0.90	R	87	160L-4	170
110	1310	13.33	11300	1.00	RF	87	160L-4	175
122	1170	11.93	11100	1.05				
147	970	9.90	10700	1.20				
160	900	9.14	11000	1.35				
178	810	8.22	10700	1.45	R	87	160L-4	170
205	700	7.13	10300	1.55	RF	87	160L-4	175
229	625	6.39	10100	1.65				
275	520	5.30	9600	1.75				
281	510	5.19	8440	1.35				
314	455	4.65	8260	1.50	RX	107	160L-4	210
348	410	4.20	8100	2.0	RXF	107	160L-4	225
383	375	3.81	7930	2.2				



技术参数

Technical Data

P ₁ = 15kW								
NA rpm	M ₂ Nm	i	Fr ₂ MAX[N]	f _s	Structure	Gear unit	Motor size	 Kg
431	330	3.38	7720	2.5				
475	300	3.07	7540	2.8				
553	260	2.64	7260	3.2				
634	225	2.30	7010	3.7	RX	107	160L-4	210
747	192	1.95	6710	4.0	RXF	107	160L-4	225
855	168	1.71	6470	4.2				
1010	142	1.44	6170	4.6				
<hr/>								
323	445	4.52	6660	1.35				
361	395	4.04	6530	1.50				
401	355	3.64	6400	1.65				
443	325	3.30	6270	1.85				
499	285	2.92	6110	2.1	RX	97	160L-4	180
552	260	2.64	5970	2.3	RXF	97	160L-4	185
652	220	2.24	5730	2.7				
746	192	1.96	5550	3.0				
892	161	1.64	5290	3.2				
1030	139	1.42	5090	3.3				
<hr/>								
420	340	3.48	4260	1.20				
473	305	3.09	4510	1.35				
529	270	2.76	4430	1.50	RX	87	160L-4	150
588	245	2.48	4350	1.65	RXF	87	160L-4	155
678	210	2.15	4230	1.80				
<hr/>								
757	189	1.93	4130	1.90	RX	87	160L-4	150
913	157	1.60	3960	2.0	RXF	87	160L-4	155
1050	137	1.39	3840	2.1				
<hr/>								
P ₁ = 18.5kW								
7.8	22500	186.93	120000	0.80				
9.6	18500	153.07	120000	1.00	R	167	180M-4	750
10	16900	139.98	120000	1.05	RF	167	180M-4	760
12	14700	121.81	120000	1.25				
<hr/>								
14	13000	107.49	120000	1.40				
16	11200	93.19	120000	1.60				
18	10000	82.91	120000	1.80	R	167	180M-4	750
20	8890	73.70	120000	2.0	RF	167	180M-4	760
22	8130	67.40	120000	2.2				
25	7070	58.65	120000	2.6				
<hr/>								
12	14500	119.86	56900	0.90	R	147	180M-4	500
13	13200	109.31	62300	1.00	RF	147	180M-4	510
15	11400	94.60	65600	1.15				
18	10100	83.47	67700	1.30				
20	8690	72.09	69500	1.50				
22	8080	66.99	70200	1.60				
24	7370	61.09	71000	1.75				



技术参数

Technical Data

P ₁ = 18.5kW								
NA rpm	M ₂ Nm	i	Fr ₂ MAX[N]	f _s	Structure	Gear unit	Motor size	 Kg
28	6380	52.87	71900	2.0	R	147	180M-4	500
31	5630	46.65	72500	2.3				
36	4860	40.29	73000	2.7				
18	9760	80.91	39000	0.80	RF	147	180M-4	510
20	8860	73.49	50200	0.90				
22	7860	65.20	53700	1.00				
25	7140	59.17	55100	1.10				
29	6130	50.86	56800	1.30	R	137	180M-4	375
33	5350	44.39	58000	1.50				
39	4540	37.65	58900	1.75				
45	3970	32.91	59500	2.0				
53	3360	27.83	60100	2.3				
50	3570	29.57	59900	2.2	RF	137	180M-4	365
61	2910	24.12	60400	2.8				
67	2650	22.00	60600	3.0				
77	2300	19.04	60800	3.5				
87	2030	16.80	60900	4.0				
36	4870	40.37	20200	0.90	R	107	180M-4	295
42	4250	35.26	22000	1.00				
50	3560	29.49	21500	1.20				
59	3000	24.90	20900	1.45	RF	107	180M-4	285
65	2730	22.62	20600	1.60				
73	2420	20.07	20100	1.80				
80	2200	18.21	19700	1.95				
94	1890	15.65	19100	2.3				
107	1650	13.66	18500	2.6				
126	1400	11.59	17800	3.1				
145	1220	10.13	17200	3.5				
186	950	7.86	16300	3.1				
220	800	6.66	15600	3.7				
73	2430	20.14	14900	1.05				
80	2200	18.24	14700	1.15				
91	1950	16.17	14500	1.25				
100	1760	14.62	14200	1.30				
118	1490	12.39	13800	1.45				
135	1310	10.83	13500	1.60				
158	1120	9.29	13400	1.80				
175	1010	8.39	13100	2.0				
206	860	7.12	12600	2.3				
236	750	6.21	12100	2.5				
282	625	5.20	11600	2.8				
326	545	4.50	11100	3.0				



技术参数

Technical Data

P ₁ = 18.5kW								
N _A rpm	M ₂ Nm	i	Fr ₂ MAX[N]	f _s	Structure	Gear unit	Motor size	 Kg
349	505	4.20	7710	1.65				
384	460	3.81	7580	1.80	RX	107	180M-4	230
433	410	3.38	7400	2.0	RXF	107	180M-4	250
477	370	3.07	7250	2.2				
555	320	2.64	7010	2.6				
636	280	2.30	6780	3.0	RX	107	180M-4	230
750	235	1.95	6510	3.3	RXF	107	180M-4	250
858	205	1.71	6290	3.4				
1015	174	1.44	6020	3.7				
402	440	3.64	6060	1.35				
444	400	3.30	5960	1.50				
501	355	2.92	5830	1.70				
554	320	2.64	5710	1.85	RX	97	180M-4	200
654	270	2.24	5510	2.2	RXF	97	180M-4	210
749	235	1.96	5350	2.4				
895	197	1.64	5120	2.6				
1035	171	1.42	4940	2.7				
531	335	2.76	3040	1.20				
590	300	2.48	3340	1.35				
680	260	2.15	3630	1.50	RX	87	180M-4	175
760	235	1.93	3820	1.55	RXF	87	180M-4	180
916	193	1.60	3770	1.65				
1055	168	1.39	3670	1.75				
P ₁ = 22kW								
9.6	22000	153.07	120000	0.80	R	167	180L-4	770
10	20100	139.98	120000	0.90	RF	167	180L-4	770
12	17500	121.81	120000	1.05				
14	15400	107.49	120000	1.15				
16	13400	93.19	120000	1.35				
18	11900	82.91	120000	1.50				
20	10600	73.70	120000	1.70	R	167	180L-4	770
22	9670	67.40	120000	1.85	RF	167	180L-4	770
25	8410	58.65	120000	2.1				
28	7420	51.76	120000	2.4				
33	6430	44.87	120000	2.8				
13	15700	109.31	41300	0.85				
15	13600	94.60	61500	0.95				
18	12000	83.47	64600	1.10				
20	10300	72.09	67300	1.25	R	147	180L-4	520
22	9610	66.99	68300	1.35	RF	147	180L-4	530
24	8760	61.09	69400	1.50				
28	7580	52.87	70800	1.70				
31	6690	46.65	71600	1.95				



技术参数

Technical Data

P ₁ = 22kW								
NA rpm	M ₂ Nm	i	Fr ₂ MAX[N]	f _s	Structure	Gear unit	Motor size	 Kg
36	5780	40.29	72400	2.3	RX	147	180L-4	520
41	5110	35.64	72900	2.5				
49	4300	29.95	73400	3.0				
22	9350	65.20	46900	0.85	R	137	180L-4	390
25	8480	59.17	51900	0.95				
29	7290	50.86	54800	1.10				
33	6370	44.39	56500	1.25				
39	5400	37.65	57900	1.50	R	137	180L-4	390
45	4720	32.91	58700	1.70				
53	3990	27.83	59500	1.90				
50	4240	29.57	59300	1.85	R	137	180L-4	380
61	3460	24.12	60000	2.3				
67	3150	22.00	60200	2.5				
77	2730	19.04	60500	2.9				
87	2410	16.80	60700	3.3	R	137	180L-4	380
101	2080	14.51	60900	3.9				
114	1840	12.83	61000	4.4				
42	5060	35.26	7280	0.85	R	107	180L-4	305
50	4230	29.49	20400	1.00				
59	3570	24.90	20000	1.20	R	107	180L-4	300
65	3240	22.62	19700	1.35				
73	2880	20.07	19300	1.50				
80	2610	18.21	19000	1.65	R	107	180L-4	300
94	2240	15.65	18500	1.90				
107	1960	13.66	18000	2.2				
126	1660	11.59	17300	2.6				
145	1450	10.13	16800	3.0				
171	1230	8.56	16100	3.5				
186	1130	7.86	16100	2.6				
220	960	6.66	15400	3.1				
252	840	5.82	14800	3.6				
73	2890	20.14	14000	0.90				
80	2620	18.24	13900	0.95				
91	2320	16.17	13700	1.05				
100	2100	14.62	13600	1.10				
118	1780	12.39	13200	1.25	R	97	180L-4	245
135	1550	10.83	13000	1.35				
158	1330	9.29	13100	1.50				
175	1200	8.39	12800	1.70				
206	1020	7.12	12300	1.95				
236	890	6.21	11900	2.1				
282	745	5.20	11400	2.4				
326	645	4.50	10900	2.5				



技术参数

Technical Data

P ₁ = 22kW								
Na rpm	M ₂ Nm	i	Fr ₂ MAX[N]	f _s	Structure	Gear unit	Motor size	 Kg
148	1420	9.90	9640	0.85				
160	1310	9.14	10100	0.90				
178	1180	8.22	9960	1.00	R	87	180L-4	205
205	1020	7.13	9700	1.05	RF	87	180L-4	215
229	920	6.39	9490	1.10				
276	760	5.30	9110	1.20				
349	600	4.20	7330	1.40				
384	545	3.81	7230	1.50	RX	107	180L-4	245
433	485	3.38	7090	1.70	RXF	107	180L-4	260
477	440	3.07	6960	1.90				
555	380	2.64	6760	2.2				
636	330	2.30	6560	2.5				
750	280	1.95	6320	2.7	RX	107	180L-4	245
858	245	1.71	6120	2.9	RXF	107	180L-4	260
1015	205	1.44	5870	3.1				
402	520	3.64	5720	1.15				
444	475	3.30	5650	1.25				
501	420	2.92	5560	1.40				
554	380	2.64	5460	1.55	RX	97	180L-4	215
654	320	2.24	5300	1.85	RXF	97	180L-4	220
749	280	1.96	5160	2.0				
895	235	1.64	4960	2.2				
1035	205	1.42	4790	2.2				
531	395	2.76	1270	1.00				
590	355	2.48	1710	1.15				
680	310	2.15	2160	1.25	RX	87	180L-4	190
760	275	1.93	2450	1.30	RXF	87	180L-4	195
916	230	1.60	2750	1.35				
1055	200	1.39	3030	1.45				
P ₁ = 30kW								
14	20900	107.49	120000	0.85	RX	167	200L-4	850
16	18200	93.19	120000	1.00	RXF	167	200L-4	860
18	16200	82.91	120000	1.10				
20	14400	73.70	120000	1.25				
22	13100	67.40	120000	1.35				
25	11400	58.65	120000	1.55				
28	10100	51.76	120000	1.80	RX	167	200L-4	850
33	8740	44.87	120000	2.1	RXF	167	200L-4	860
37	7780	39.92	120000	2.3				
43	6710	34.41	120000	2.7				
53	5450	27.96	120000	3.3				
62	4620	23.71	120000	3.9				



技术参数

Technical Data

P ₁ = 30kW								
NA rpm	M ₂ Nm	i	Fr ₂ MAX[N]	f _s	Structure	Gear unit	Motor size	 Kg
18	16300	83.47	32400	0.80				
20	14000	72.09	60400	0.95	R	147	200L-4	600
22	13100	66.99	62500	1.00	RF	147	200L-4	610
24	11900	61.09	64700	1.10				
28	10300	52.87	67300	1.25				
32	9090	46.65	69000	1.45				
36	7850	40.29	70500	1.65	R	147	200L-4	600
41	6950	35.64	71400	1.85	RF	147	200L-4	610
49	5840	29.95	72300	2.2				
61	4710	24.19	73100	2.5				
72	3980	20.44	73600	3.0	R	147	200L-4	590
82	3510	18.04	73800	3.0	RF	147	200L-4	600
94	3050	15.64	74000	4.3				
29	9910	50.86	35800	0.80				
33	8650	44.39	51200	0.90	R	137	200L-4	475
39	7340	37.65	54700	1.10	RF	137	200L-4	500
45	6410	32.91	56400	1.25				
53	5420	27.83	57900	1.40				
61	4700	24.12	58800	1.70	R	137	200L-4	465
67	4290	22.00	59200	1.85	RF	137	200L-4	490
77	3710	19.04	59800	2.2				
88	3270	16.80	60100	2.4				
101	2830	14.51	59500	2.8	R	137	200L-4	465
115	2500	12.83	58400	3.2	RF	137	200L-4	490
136	2100	10.79	56600	3.8				
194	1480	7.59	53300	3.5				
230	1240	6.38	51300	4.1				
73	3910	20.07	17600	1.10				
81	3550	18.21	17400	1.20				
94	3050	15.65	17100	1.40				
108	2660	13.66	16800	1.60				
127	2260	11.59	16300	1.90	R	107	200L-4	385
145	1970	10.13	15900	2.2	RF	107	200L-4	390
172	1670	8.56	15400	2.6				
187	1530	7.86	15500	1.95				
221	1300	6.66	14900	2.3				
252	1140	5.82	14400	2.6				
299	960	4.92	13700	3.0				
101	2850	14.62	12000	0.80				
119	2420	12.39	11900	0.90	R	97	200L-4	330
136	2110	10.83	11800	1.00	RF	97	200L-4	345
158	1810	9.29	12300	1.10				
175	1640	8.39	12100	1.25				



技术参数

Technical Data

P₁ = 30kW								
-----------------------------	--	--	--	--	--	--	--	--

N _A rpm	M ₂ Nm	i	Fr ₂ MAX[N]	f _s	Structure	Gear unit	Motor size	Kg
207	1390	7.12	11700	1.45				
237	1210	6.21	11400	1.55	R	97	200L-4	330
283	1010	5.20	10900	1.75	RF	97	200L-4	345
327	880	4.50	10500	1.85				
<hr/>								
434	660	3.38	6370	1.25				
479	600	3.07	6310	1.40				
557	515	2.64	6180	1.60	RX	107	200L-4	330
638	450	2.30	6050	1.85	RXF	107	200L-4	345
752	380	1.95	5870	2.0				
860	335	1.71	5720	2.1				
1020	280	1.44	5520	2.3				
<hr/>								
503	570	2.92	3120	1.05				
556	515	2.64	3560	1.15				
656	435	2.24	4050	1.35	RX	97	200L-4	295
751	380	1.96	4450	1.50	RXF	97	200L-4	305
898	320	1.64	4580	1.60				
1040	275	1.42	4450	1.65				

P₁ = 37kW								
-----------------------------	--	--	--	--	--	--	--	--

16	22400	93.19	120000	0.80				
18	19900	82.91	120000	0.90				
20	17700	73.70	120000	1.00				
22	16200	67.40	120000	1.10				
25	14100	58.65	120000	1.30	R	167	225S-4	900
28	12400	51.76	120000	1.45	RF	167	225S-4	900
33	10800	44.87	120000	1.65				
37	9600	39.92	120000	1.90				
43	8270	34.41	120000	2.2				
53	6720	27.96	120000	2.7				
<hr/>								
48	7380	30.71	120000	1.35				
60	5900	24.57	120000	2.4	R	167	225S-4	890
67	5250	21.85	120000	2.5	RF	167	225S-4	900
77	4580	19.03	120000	3.5				
87	4080	16.98	120000	3.7				
<hr/>								
22	16100	66.99	35000	0.80				
24	14700	61.09	54200	0.90				
28	12700	52.87	63200	1.00				
32	11200	46.65	65900	1.15				
36	9680	40.29	68200	1.35				
41	8570	35.64	69700	1.50	R	147	225S-4	650
49	7200	29.95	71100	1.80	RF	147	225S-4	660
61	5810	24.19	72400	2.1				
72	4910	20.44	73000	2.4				
82	4340	18.04	73400	2.4				
94	3760	15.64	73700	3.5				



技术参数

Technical Data

P₁ = 30kW								
-----------------------------	--	--	--	--	--	--	--	--

N _A rpm	M ₂ Nm	i	Fr ₂ MAX[N]	f _s	Structure	Gear unit	Motor size	Kg
106	3340	13.91	73900	3.8	R	147	225S-4	650
					RF	147	225S-4	660
39	9050	37.65	49400	0.90	R	137	225S-4	520
45	7910	32.91	53600	1.00	RF	137	225S-4	550
53	6690	27.83	55900	1.15				
61	5800	24.12	57300	1.40	R	137	225S-4	510
67	5290	22.00	58000	1.50	RF	137	225S-4	540
77	4580	19.04	57800	1.75				
88	4040	16.80	57300	2.0				
101	3490	14.51	56600	2.3	R	137	225S-4	510
115	3080	12.83	55800	2.6	RF	137	225S-4	540
136	2590	10.79	54400	3.1				
169	2090	8.71	52600	3.7				
194	1820	7.59	51900	2.8				
230	1530	6.38	50100	3.3				
285	1240	5.15	47800	3.7				
73	4820	20.07	16100	0.90	R	107	225S-4	435
81	4380	18.21	16100	1.00	RF	107	225S-4	440
94	3760	15.65	15900	1.15				
108	3280	13.66	15700	1.30				
127	2790	11.59	15400	1.55				
145	2430	10.13	15100	1.75				
172	2060	8.56	14700	2.1				
187	1890	7.86	15000	1.55				
221	1600	6.66	14400	1.85				
252	1400	5.82	14000	2.1				
299	1180	4.92	13400	2.5				
434	810	3.38	4470	1.00	RX	107	225S-4	380
479	740	3.07	4950	1.10	RXF	107	225S-4	395
557	635	2.64	5530	1.30				
638	555	2.30	5610	1.50				
752	470	1.95	5490	1.65				
860	410	1.71	5370	1.70				
1020	345	1.44	5220	1.85				

P₁ = 45kW								
-----------------------------	--	--	--	--	--	--	--	--

20	21500	73.70	120000	0.85	R	167	225M-4	930
22	19700	67.40	120000	0.90	RF	167	225M-4	930
25	17100	58.65	120000	1.05				
28	15100	51.76	120000	1.20				
33	13100	44.87	120000	1.35				
37	11700	39.92	120000	1.55				
43	10100	34.41	120000	1.80				
53	8170	27.96	120000	2.2				
62	6930	23.71	120000	2.6				



技术参数

Technical Data

P ₁ = 45kW								
NA rpm	M ₂ Nm	i	Fr ₂ MAX[N]	f _s	Structure	Gear unit	Motor size	 Kg
48	8980	30.71	120000	1.10				
60	7180	24.57	120000	1.95	R	167	225M-4	930
67	6390	21.85	120000	2.0	RF	167	225M-4	930
77	5560	19.03	120000	2.9				
87	4960	16.98	120000	3.0				
28	15500	52.87	44400	0.85				
32	13600	46.65	61300	0.95				
36	11800	40.29	65000	1.10	R	147	225M-4	680
41	10400	35.64	67200	1.25	RF	147	225M-4	690
49	8760	29.95	69400	1.50				
61	7070	24.19	71300	1.70				
72	5970	20.44	72200	2.0				
82	5270	18.04	72800	2.0				
94	4570	15.64	73200	2.8	R	147	225M-4	670
106	4070	13.91	73500	3.1	RF	147	225M-4	680
123	3510	11.99	73800	3.7				
203	2120	7.25	74300	4.1				
45	9620	32.91	41700	0.85	R	137	225M-4	550
53	8130	27.83	51200	0.95	RF	137	225M-4	580
61	7050	24.12	52400	1.15				
67	6430	22.00	52900	1.25	R	137	225M-4	540
77	5570	19.04	53300	1.45	RF	137	225M-4	570
88	4910	16.80	53400	1.65				
101	4240	14.51	53200	1.90				
115	3750	12.83	52800	2.1				
136	3150	10.79	51900	2.5	R	137	225M-4	540
169	2550	8.71	50500	3.1	RF	137	225M-4	570
194	2220	7.59	50200	2.3				
230	1860	6.38	48700	2.7				
285	1510	5.15	46700	3.1				
94	4580	15.65	14600	0.95				
108	3990	13.66	14600	1.10				
127	3390	11.59	14400	1.25				
145	2960	10.13	14300	1.45	R	107	225M-4	460
172	2500	8.56	14000	1.70	RF	107	225M-4	465
187	2300	7.86	14400	1.30				
221	1950	6.66	14000	1.50				
252	1700	5.82	13600	1.75				
299	1440	4.92	13100	2.0				
434	990	3.38	1360	0.85				
479	900	3.07	2080	0.90				
557	770	2.64	2970	1.10	RX	107	225M-4	405
638	675	2.30	3640	1.25	RXF	107	225M-4	420
752	570	1.95	4200	1.35				



技术参数

Technical Data

P₁ = 45kW								
-----------------------------	--	--	--	--	--	--	--	--

N _A rpm	M ₂ Nm	i	Fr ₂ MAX[N]	f _s	Structure	Gear unit	Motor size	Kg
860	500	1.71	4540	1.40	RX	107	225M-4	405
1020	420	1.44	4880	1.55	RXF	107	225M-4	420

P₁ = 55kW								
-----------------------------	--	--	--	--	--	--	--	--

25	20900	58.65	120000	0.85				
29	18400	51.76	120000	1.00				
33	16000	44.87	120000	1.15	R	167	250M-4	1060
37	14200	39.92	120000	1.25	RF	167	250M-4	1060
43	12300	34.41	120000	1.45				
53	9960	27.96	120000	1.80				
62	8440	23.71	120000	2.1				
60	8750	24.57	120000	1.60	R	167	250M-4	1050
68	7780	21.85	120000	1.65	RF	167	250M-4	1060
77	6780	19.03	120000	2.4				
87	6050	16.98	120000	2.5	R	167	250M-4	1050
102	5150	14.48	120000	3.5	RF	167	250M-4	1060
123	4270	11.99	120000	4.0				
32	16600	46.65	26600	0.80				
37	14300	40.29	58200	0.90	R	147	250M-4	800
41	12700	35.64	63300	1.00	RF	147	250M-4	810
49	10700	29.95	66800	1.20				
61	8610	24.19	69600	1.40				
72	7280	20.44	71100	1.65				
82	6420	18.04	71900	1.65	R	147	250M-4	790
94	5570	15.64	72500	2.3	RF	147	250M-4	800
106	4950	13.91	73000	2.5				
123	4270	11.99	73400	3.0				
151	3470	9.74	73800	3.8	R	147	250M-4	790
203	2580	7.25	74200	3.4	RF	147	250M-4	800
250	2100	5.89	72500	4.1				
77	6780	19.04	47800	1.20	R	137	250M-4	660
88	5980	16.80	48500	1.35	RF	137	250M-4	690
102	5170	14.51	48900	1.55				
115	4570	12.83	49000	1.75				
137	3840	10.79	48800	2.1				
169	3100	8.71	48000	2.5	R	137	250M-4	660
194	2700	7.59	48100	1.90	RF	137	250M-4	690
231	2270	6.38	46900	2.3				
286	1830	5.15	45200	2.5				

P₁ = 75kW								
-----------------------------	--	--	--	--	--	--	--	--

33	21700	44.87	120000	0.85	R	167	280S-4	1190
37	19300	39.92	120000	0.95	RF	167	280S-4	1190



技术参数

Technical Data

P₁ = 75kW								
-----------------------------	--	--	--	--	--	--	--	--

N _A rpm	M ₂ Nm	i	Fr ₂ MAX[N]	f _s	Structure	Gear unit	Motor size	Kg
43	16700	34.41	120000	1.10	R	167	280S-4	1190
53	13500	27.96	120000	1.35	RF	167	280S-4	1190
62	11500	23.71	120000	1.55				
60	11900	24.57	120000	1.20	R	167	280S-4	1180
68	10600	21.85	120000	1.25	RF	167	280S-4	1190
78	9210	19.03	120000	1.75				
87	8220	16.98	120000	1.85				
102	7000	14.48	120000	2.6	R	167	280S-4	1180
123	5800	11.99	116600	2.9	RF	167	280S-4	1190
145	4950	10.24	112800	3.4				
49	14500	29.95	56500	0.90	R	147	280S-4	940
61	11700	24.19	65100	1.00	RF	147	280S-4	950
72	9890	20.44	67900	1.20				
82	8730	18.04	69500	1.20	R	147	280S-4	930
95	7570	15.64	70800	1.70	RF	147	280S-4	940
106	6730	13.91	71600	1.85				
123	5800	11.99	72400	2.2				
152	4710	9.74	73100	2.8				
179	4000	8.26	73500	3.3	R	147	280S-4	930
204	3510	7.25	73100	2.5	RF	147	280S-4	940
251	2850	5.89	70100	3.0				
296	2420	5.00	67600	3.6				

P₁ = 90kW								
-----------------------------	--	--	--	--	--	--	--	--

37	23200	39.92	120000	0.80				
43	20000	34.41	120000	0.90	R	167	280M-4	1260
53	16200	27.96	120000	1.10	RF	167	280M-4	1270
62	13800	23.71	120000	1.30				
60	14300	24.57	120000	1.00	R	167	280M-4	1260
68	12700	21.85	120000	1.00	RF	167	280M-4	1260
78	11100	19.03	120000	1.45				
87	9860	16.98	120000	1.50				
102	8410	14.48	117300	2.1	R	167	280M-4	1260
123	6960	11.99	113500	2.4	RF	167	280M-4	1260
145	5940	10.24	110100	2.9				
72	11900	20.44	64800	1.00				
82	10500	18.04	67100	1.00	R	147	280M-4	1000
95	9080	15.64	69000	1.45	RF	147	280M-4	1010
106	8080	13.91	70200	1.55				



技术参数

Technical Data

P ₁ = 90kW								
NA rpm	M ₂ Nm	i	Fr ₂ MAX[N]	f _s	Structure	Gear unit	Motor size	 Kg
123	6960	11.99	71400	1.85				
152	5660	9.74	72500	2.3				
179	4800	8.26	73000	2.7	R	147	280M-4	1000
204	4210	7.25	70900	2.1	RF	147	280M-4	1010
251	3420	5.89	68300	2.5				
296	2900	5.00	66100	3.0				
P ₁ = 110kW								
53	19800	27.96	117100	0.90	R	167	315S-4	1450
63	16800	23.71	116900	1.05	RF	167	315S-4	1460
78	13500	19.03	115500	1.20				
87	12000	16.98	114300	1.25	R	167	315S-4	1440
103	10200	14.48	112200	1.75	RF	167	315S-4	1450
124	8480	11.99	109300	2.0				
145	7240	10.24	106500	2.4				
P ₁ = 132kW								
63	20100	23.71	107900	0.90				
78	16200	19.03	108300	1.00				
87	14400	16.98	107800	1.05	R	167	315M1-4	1550
103	12300	14.48	106700	1.45	RF	167	315M1-4	1560
124	10200	11.99	104700	1.65				
145	8690	10.24	102600	1.95				
P ₁ = 160kW								
103	14900	14.48	99700	1.20	R	167	315M2-4	1540
124	12300	11.99	98900	1.40	RF	167	315M2-4	1550
145	10500	10.24	97600	1.60				